



f920x

Car Camcorder
行車記錄器 **(GPS)**

User Manual
使用說明書



f920x

**Car Camcorder
User Manual**

Contents

About this Guide	3
Regulatory notices.....	3
Prohibition of co-location	3
WEEE Notice.....	3
CE Regulatory Notice	4
Notes on Installation	4
Caution	4
1 Introduction.....	7
1.1 Features.....	7
1.2 Package Contents	7
1.3 Product Overview.....	8
2 Getting Started	9
2.1 Storage Media.....	9
2.1.1 Insert the Memory Card	9
2.1.2 Remove the Memory Card.....	9
2.2 Installing in Vehicles	10
2.2.1 Mount the Camcorder to Windshield.....	10
2.3 Change Bracket.....	12
2.4 Connecting to Power.....	13
2.5 LED Indicator.....	13
2.6 Powering the Camcorder On / Off	14
2.6.1 Auto Power On/Off.....	14
2.6.2 Manual Power On/Off.....	14
2.6.3 Reset	14
2.7 Initial Settings.....	14
2.7.1 Set Time zone	15
2.7.2 Set the Date / Time	16
3 Using the Car Camcorder	17
3.1 Automatic Record	17

3.1.1	The Recording Screen.....	18
3.1.2	Emergency Recording	20
3.2	Picture in Video	20
3.3	Driving Safety	21
3.3.1	Speed Cam Alert.....	21
3.3.2	Add Speed Point	22
3.3.3	Speed Limit Alert.....	22
3.3.4	Driver Fatigue Alert	23
3.3.5	LDWS	23
3.3.6	FCWS	25
4	Initial set up Go Dashcam application	32
5	Using the Go Dashcam application	34
6	Adjusting the Settings	40
7	SuperCar 2.0	44
8	Specifications	45

About this Guide

The content in this document is for information purpose and is subject to change without prior notice. We have made every effort to ensure that this User Guide is accurate and complete.

However, no liability is assumed for any errors or omissions that may have occurred.

The manufacturer reserves the right to change the technical specifications without prior notice.

Regulatory notices

This document provides country- and region-specific non-wireless and wireless regulatory notices and compliance information for your product. Some of these notices may not apply to your product.

Disposal of a battery into fire or a hot oven, or mechanically crushing or cutting of a battery, that can result in an explosion.

Leaving a battery in an extremely high temperature surrounding environment that can result in an explosion or the leakage of flammable liquid or gas.

Prohibition of co-location

This device and its antenna(s) must not be co-located or operated in conjunction with any other antenna or transmitter.

WEEE Notice

Disposal of Waste Electrical and Electronic Equipment and/or Battery by users in private households in the European Union



WEEE



Battery

This symbol on the product or on the packaging indicates that this cannot be disposed of as a household waste. You must dispose of your waste equipment and/or battery by handling it over to the applicable take-back scheme for the recycling of electrical and electronic equipment and/or battery. For more information about recycling of this equipment and/or battery, please contact your city office, the shop where you purchased the equipment or your household waste disposal service. The recycling of

materials will help to conserve natural resources and ensure that it is recycled in a manner that protects human health and environment.

CE Regulatory Notice

The product herewith complies with the requirements of the Low Voltage Directive 2014/35/EU, the EMC Directive 2014/30/EU, the RED-Directive 2014/53/EU and the RoHS Directive 2011/65/EU.

EU Health Protection: This equipment should be installed and operated with minimum distance 20cm between the radiator & your body.

Notes on Installation

1. Please measure the front windshield viewing area, make sure not to block driver's front view, install the camcorder below the rearview mirror (the central, higher right position of the front windshield). And we recommend that the sky and the land occupied by the screen 50%, fix the car holder and then adjust the camcorder so that the lane is aligned with the screen. Proper installation enables the camcorder to maximize the efficiency also can enhance the accuracy of LDWS.
2. Make sure that the lens is within the wiping range of the windscreen wiper to ensure a clear view even when it rains.
3. Do not touch the lens with your fingers. Finger grease may be left on the lens and will result in unclear videos or pictures. Clean the lens on a regular basis.
4. Do not install the camcorder on a tinted window. Doing so may damage the tint film.
5. Make sure that the installation position is not hindered by the tinted window.
6. This product is suitable for light windshield or light color heat-resistant film windows, it will affect video quality if install it on the dark windows or dark heat-resistant film windows.
7. Use the products of the attached power charger only, please do not use other brand power charger, in order to avoid equipment burn.

Caution

- ❖ Due to local laws and vehicles safety considerations, do not operate the camcorder while driving.
- ❖ Set up time zone, time and date accurately before you use this camcorder.

- ❖ Please use SuperCar software under the condition that Electronic Map are functioning normally.
- ❖ The firmware function in the camcorder is for reference only, drivers are advised to exercise discretion based on actual road conditions.
- ❖ The results of GPS positioning are only for reference, and should not affect the actual driving situation. The camcorder also cannot ensure the positioning accuracy.
- ❖ GPS positioning accuracy may differ depending on weather and location such as high buildings, tunnels, undergrounds, or forests. GPS satellite signals cannot pass through solid materials (except glass). Tinted window will also affect the performance of the GPS satellite reception.
- ❖ GPS reception performance on each camcorder may differ. The camcorder cannot determine the accuracy of the positioning results from different hardware.
- ❖ The values displayed in this camcorder, such as speed and position, may be inaccurate due to the influence of surrounding environment. They are for your reference only.
- ❖ This product is used only for non-commercial use, within the maximum limits permitted by applicable law. We do not take any responsibilities for the loss of use of the product.
- ❖ Wi-Fi Signals are unable to pass through the building. The upper limit of signal transmission is 5m.
- ❖ Wi-Fi Operation Channel: Ch1~Ch13
- ❖ The product employs wireless data communication which may interfere, or be interfered by, a near-by camcorder.
- ❖ Never use this camcorder in the vicinity of a microwave oven or at places where there is radio interference.
- ❖ Radio wave reception may be worsened in specific environments.
- ❖ Please be advised that if another camcorder is also using the same 2.4GHz band as this product, the processing speed of both camcorders may slow down.
- ❖ This camcorder gets warm when in use; this is normal.
- ❖ Improper use or operation of the product may result in damage of the product or its accessories and void the warranty.
- ❖ The radio frequency (RF) generated by this RF electronic camcorder may cause adverse effects on the operation of other electronic

camcorders and result in malfunctioning. Wireless transmitters and circuitry may also interfere with other electronic camcorders. Therefore, do observe the following precautions:

- **Aircraft:** Never use a radio transmitter when you are in an airplane. Please switch off the Wi-Fi function of the camcorder.
 - **Vehicle:** The radio frequency transmitted by this camcorder may affect the electronic system in a motorized vehicle. Please consult the manufacturer or dealer of your vehicle on the possible effect.
 - **Pacemaker:** In order to prevent any potential interference to a pacemaker, anyone who uses a pacemaker should be advised, that, when using this camcorder, a minimum distance of 15cm (6 inch) should be kept between the camcorder and the pacemaker; and never put this camcorder in a chest pocket. In case of any doubt of interference, switch off the camcorder immediately.
 - **Medical Camcorder:** If you use a personal medical camcorder, consult the camcorder manufacturer or your physician to confirm if your camcorder is sufficiently shielded from the RF transmission of this camcorder.
 - **Medical Facilities:** Hospitals and medical institutes may use facilities that are sensitive to an external RF energy. Observe such instructions when the medical care personnel or any posted sign requests you to switch off any camcorder that may interfere the radio frequency.
 - **Explosion sites or any location with a posted sign:** In order to prevent interfering with an explosion activity, observe all the signage and instructions in the Explosion Area or in a zone with a “Switch Off 2-way Radios” sign by switching off camcorders that may interfere with the radio frequency.
- ❖ HP Inc. is NOT responsible for the loss of any data/content during operation.

Before you start using the product, it is assumed that you agree to the above statement.

1 Introduction







Thank you for purchasing this advanced Car Camcorder. This product is specifically designed for real time video recording when driving. It also supports a HP rear camera. You might ask distributor for further information.

1.1 Features

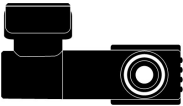
- Full HD 1920*1080
- 1.3" TFT-LCD color screen
- Wide angle lens
- Collision Detection, when a collision is detected, the camcorder will automatically trigger the emergency recording
- Parking Mode
- Multifunction traffic safety reminder

1.2 Package Contents

The package contains the following items. In case there is any missing or damaged item, contact your dealer immediately.

Car Camcorder	3M Adhesive Bracket	Electrostatic Sticker	Bracket
			
User Manual	Car Adapter	Rear Camera (option)	
			

1.3 Product Overview

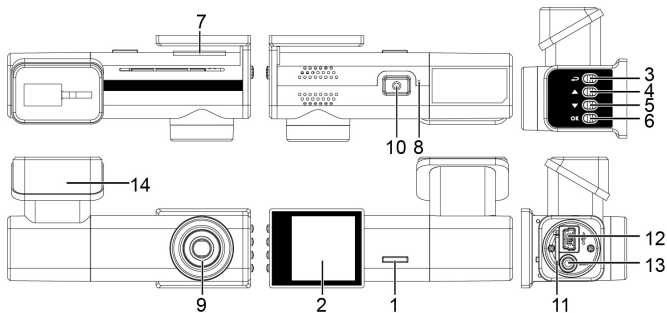

No.	Item
1	LED Indicator
2	LCD Panel
3	Menu / Back Button (☰ / ←)
4	Add Speed Cam / Up Button (📷 / ▲)
5	Snapshot / Down Button (📷 / ▼)
6	Emergency Recording / Confirm Button (⚠️ / 🔒)
7	Speaker

No.	Item
8	Microphone
9	Wide Angle Lens
10	Power button
11	Memory Card Slot
12	Power Connector
13	Rear camera connector port (option)
14	Bracket Socket

2 Getting Started

2.1 Storage Media

2.1.1 Insert the Memory Card

Insert memory card with the pins facing forward and the screen of the camcorder facing forward too, see the picture as below:

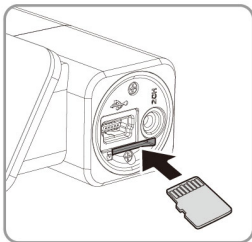

2.1.2 Remove the Memory Card

If the camcorder is power on, please power off first and wait for the procedure of switching off the camcorder completed before removing the memory card.

Note:

1. Do not remove or insert the memory card when the camcorder is turned on. This may damage the memory card.
2. Support microSD class 10 and memory storage 16GB or above (support up to 128GB).
3. Please use this car camcorder to format the microSD card before the initial use. The formatted file type for this camcorder is FAT32.
4. Periodically format the microSD card (recommended period: once a month).

2.2 Installing in Vehicles

2.2.1 Mount the Camcorder to Windshield

1. Before putting the bracket, please wipe and clean the windshield.

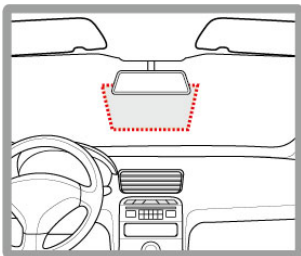

2. Attach the bracket to the camcorder.
Slide it into the bracket holder until you hear a "click" sound.

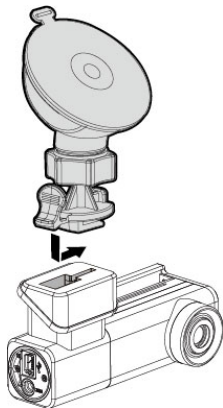

3. Before installing the bracket, please use alcohol to clean the windshield and suction cup of the bracket. Wait for dry and press suction-cup on the windshield.
4. Hold the base firmly on the windshield and press down the clamp to mount the car holder to the windshield. Make sure the base is securely locked in place.

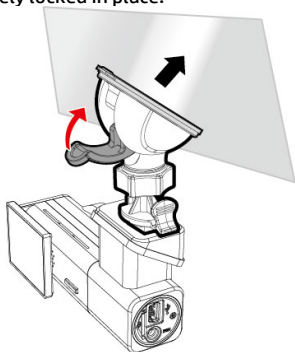

2.2.2 Adjust the Camcorder

1. Loosen the knob to swivel the device vertically or horizontally.

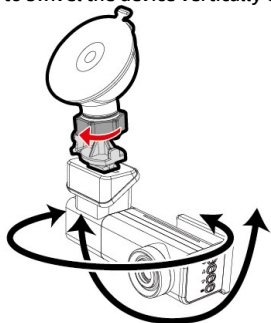

2. Then tighten the knob to make sure the camcorder is securely locked in place.

2.3 Change Bracket

1. Push out the T-type trestle.
2. After disassemble trestle, you can see two notches and one up-side arrow.
3. Take 3M Adhesive Bracket and make sure the arrow on the bracket is also up-side sign. Turn around the bracket for replacement.
4. Put two hooks of the bracket into the notches. Push up the bracket until “click” sound is heard.

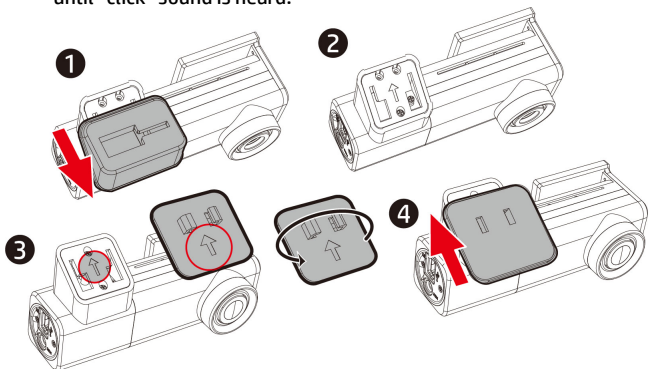

Note:

Use the 3M Adhesive Bracket to install in the car, please put the electrostatic sticker onto the suggested area on the windshield. Before putting the sticker, please wipe and clean the windshield. During the installation, please make sure the bubbles in between the sticker and the window are all gone. Peel off the protective plastic sheet from the bracket. Place and press the bracket firmly onto the electrostatic sticker on the windshield window. Make sure the base is securely locked in place.

2.4 Connecting to Power

Use only the attached power connector for activating the camcorder.

1. Connect one end of power connector to power connector port on the camcorder. USB port input: DC 5V / 2A.
2. Plug the other end of the car adapter to the cigarette lighter socket of your vehicle. Once the vehicle engine is started, the camcorder automatically turns on. Car charger input: DC 12 / 24V.

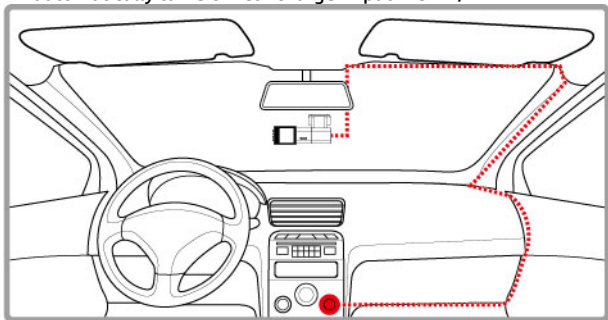

Note:

Use the products of the attached power charger only, please do not use other brand power charger, in order to avoid equipment burn.

2.5 LED Indicator

Status Explanation	LED Indicator Color
Power off, connect external power	Red
Power on, standby	Green
Recording/ Recording and screen off	Flash red

2.6 Powering the Camcorder On / Off

2.6.1 Auto Power On/Off

If the camcorder is connected to the vehicle power supply, once start the car engine, the camcorder will automatically power on and start recording.

Once the vehicle engine shuts down, the camcorder automatically saves the recording and turns off the power.

2.6.2 Manual Power On/Off

To manually turn on the power, press the **POWER** button.

To turn off, press and hold the **POWER** button for at least 2 seconds.

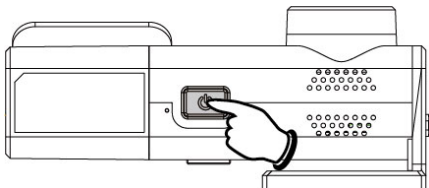

2.6.3 Reset

Press and hold the Power button for 8 seconds to reset the device.

2.7 Initial Settings







Before using the camcorder, we recommend you setup the correct **Time zone, Date and Time**.

Note:

Please note that if you press the  button during recording, the system will stop recording and enter OSD menu. Make sure the recording is already stopped then continue operating the menu.

2.7.1 Set Time zone

To set the time zone, do the following:





1. Press the  button to enter the OSD menu.
2. Press the  button to select **Set Time zone**, and then press the  button for entering function menu.
3. Press the  button to set the current time zone, and then press the  button to complete setting.
4. Press the  button to return to recording screen.

City	UTC	City	UTC	City	UTC	City	UTC	City	UTC
Accra	0	Budapest *	+1	Houston *	-6	Melbourne	+10	Santiago	-4
Addis Ababa	+3	Buenos Aires	-3	Indianapolis *	-5	Mexico City *	-6	Santo Domingo	-4
Adelaide **	+9	Cairo	+2	Islamabad	+5	Miami *	-5	São Paulo	-3
Algiers	+1	Calgary *	-7	Istanbul *	+2	Minneapolis *	-6	Seattle *	-8
Almaty	+6	Canberra	+10	Jakarta	+7	Minsk	+3	Seoul	+9
Amman *	+2	Cape Town	+2	Jerusalem *	+2	Montevideo	-3	Shanghai	+8
Amsterdam *	+1	Caracas **	-4	Johannesburg	+2	Montreal *	-5	Singapore	+8
Anadyr	+12	Casablanca *	0	Kabul **	+4	Moscow	+4	Sofia *	+2
Anchorage *	-9	Chicago *	-6	Karachi	+5	Mumbai **	+5	St. John's **	-3
Ankara *	+2	Columbus *	-5	Kathmandu **	+5	Nairobi	+3	Stockholm *	+1
Antananarivo	+3	Copenhagen *	+1	Khartoum	+3	Nassau *	-5	Suva	+12
Asuncion	-4	Dallas *	-6	Kingston	-5	New Delhi **	+5	Sydney	+10
Athens *	+2	Dar es Salaam	+3	Kinshasa	+1	New Orleans *	-6	Taipei	+8
Auckland *	-5	Darwin **	+9	Kiritimati	+14	New York *	-5	Tallinn *	+2
Baghdad	+12	Denver *	-7	Kolkata **	+5	Oslo *	+1	Tashkent	+5
Baghdad	+3	Detroit *	-5	Kuala Lumpur	+8	Ottawa *	-5	Tegucigalpa	-6
Bangalore	+5	Dhaka	+6	Kuwait City	+3	Paris *	+1	Tehran **	+3
Bangkok	+7	Doha	+3	Kyiv *	+2	Perth	+8	Tokyo	+9
Barcelona *	+1	Dubai	+4	La Paz	-4	Philadelphia *	-5	Toronto *	-5
Beijing	+8	Dublin *	0	Lagos	+1	Phoenix	-7	Vancouver *	-8
Beirut *	+2	Edmonton *	-7	Lahore	+5	Prague *	+1	Vienna *	+1
Belgrade *	+1	Frankfurt *	+1	Las Vegas *	-8	Reykjavik	0	Warsaw *	+1
Berlin *	+1	Guatemala	-6	Lima	-5	Rio de Janeiro	-3	Washington DC *	-5
Bogota	-5	Halifax *	-4	Lisbon *	0	Riyadh	+3	Winnipeg *	-6
Boston *	-5	Hanoi	+7	London *	0	Rome *	+1	Yangon **	+6
Brasilia	-3	Harare	+2	Los Angeles *	-8	Salt Lake City *	-7	Zagreb *	+1
Brisbane	+10	Havana *	-5	Madrid *	+1	San Francisco *	-8	Zürich *	+1
Brussels *	+1	Hong Kong	+8	Managua	-6	San Juan	-4		
Bucharest *	+2	Honolulu	-10	Manila	+8	San Salvador	-6		

Note: If satellite positioning is not successful, camcorder clock will run based on user defined time.

2.7.2 Set the Date / Time

To set the correct date and time, do the following:

1. Press the  button to enter the OSD menu.
2. Press the  button to select **Date / Time**, and then press the  button for entering function menu.
3. Press the  button to adjust the value, and then press the  button to set the next field.
4. Repeat step 3 until the date and time setting is completed.

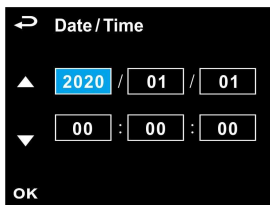

Note:

To ensure the accuracy of the video file time, please reset the date and time when not in use over 7 days.

3 Using the Car Camcorder

3.1 Automatic Record

Start the car engine, wait a few seconds to charge the camcorder, and then screen will light up and the camcorder will automatically power on and start recording.

Recording will automatically stop when the engine is switched off.







Note:

1. Some vehicle power supply would not turn on / off automatically with the car engine start, if the camcorder cannot automatically power on/off with the car engine, please manually connect the power supply with the vehicle power, and then power on, or manually power off the camcorder and then release the connector with the car power supply.
2. It can be configured to save a video file for every 30 seconds, 1 or 3 minutes of recording.
3. All the videos and photos are saved in the memory card, if memory card is full, loop recording will be generally overwrite the oldest video file.
4. The camcorder is built-in super capacitor. After start the car engine, please wait a few seconds for charging the camcorder, and then the camcorder will automatically power on and start recording.

3.1.1 The Recording Screen



No.	Icon	Item	Description
1		Recording Duration	Indicates the video current duration.
2		Date / Time	Indicates the current recording date and time.
3		Menu Button	During video recording, press the button to enter the Menu.
4		Add Speed Point Button	During video recording, press the button to add a speed cam point.
5		PIV (Picture in Video) Button	Press to capture video screen shots.
6		Emergency Recording Button	During video recording, press the button to enter emergency recording mode.
7		Resolution icon	Indicates the video resolution.

8		Voice Record icon	Indicates voice recording sets as off, the sound will not be recorded.
9		Satellite Positioning icon	Indicates the strength of satellite positioning. If the icon shows in red on screen, it indicates that the camcorder cannot complete the satellite positioning.
10		Wi-Fi	 Wi-Fi on  Wi-Fi off
11		VIV (Video in Video)	Indicates rear camera recording screen. (Rear Camera is not included in standard package. Please contact distributor for further information.)

3.1.2 Emergency Recording

To Start the Emergency Recording, do the following:

1. During Video Recording, press the  button to enter emergency recording mode, the “**Emergency**” message will be shown immediately on the upper left corner of the screen, and the recorded file will be protected.
2. The emergency video recording length is same as the recording interval setting. When the emergency recording length reaches the setting, the system will return to the general recording mode.

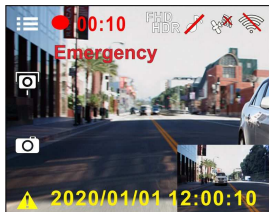



Note:

1. If the *Collision Detection* function is enabled and a collision is detected, the camcorder will automatically trigger the emergency recording.
2. The emergency file is created as a new file and saved in Emergency folder, which will be protected to avoid being overwritten by normal loop recording. The Emergency folder will occupy 40% of available memory card capacity. For example, if you use 8GB memory card, about 3.2GB memory space will be saved for emergency files. When the Emergency folder is full, the oldest emergency file will be automatically deleted by the newest emergency file.

3.2 Picture in Video

You can also use this camcorder to take snapshots of the current scene.

1. In recording status, press  to capture recording screen shot.
2. When the icon  shows in the central of screen, it means the screenshots is completed.



Note:

1. The screen shots image resolution quality is depending on the video resolution setting.
2. The definition of picture in video by this product, the picture resolution is limited by the speed of the target object and changes in ambient lighting. The photograph function is better used for taking still pictures in accident scenes or when the car is stopped to wait for a traffic light.

3.3 Driving Safety

The following driving safety function is for reference only. Drivers are advised to exercise discretion based on actual road conditions.







Note:

1. The *Driving Safety* function is limited to triggering no more than two alarms at the same time. If a voice and alert message have been triggered, any other alarm will be ignored until either of the two is settled.
2. Satellite positioning must be completed before functions such as *Speed Cam Alert*, *Speed Position Management*, *Speed Limit Alert*, *LDWS* and *FCWS* to be enabled. Be sure to check that Satellite positioning has been completed prior to using the product.
3. The detections of *LDWS* and *FCWS* may be inaccurate when used in rain, at night or in environments of insufficient lighting. Drivers are advised to exercise discretion based on actual road conditions.

3.3.1 Speed Cam Alert

If the **Speed Cam Alert** function is enabled, once your car's location is determined by GPS and approaches a speed cam, this product produces audible alert and screen message.

To enable the Speed Cam Alert, do the following:

1. Press the  button to enter the OSD menu.
2. Press the  button to select **Speed Cam Alert**, and then press the  button for entering function menu.
3. Press the  button to select **On**, and then press the  button to enable the function.
4. Press the  button to return recording screen.
5. The alarm screen turns red to remind you to slow down if you are driving faster than the speed limit.



Note:

The speed cam alert function must have the speed cam datum from the country you use. The function will be void if the product is used in any others countries. Please consult with the shop you purchased if the function is void. There is no guarantee the speed cam datum will be included for the worldwide countries.

3.3.2 Add Speed Point

You may customize speed cam positions in this product.

1. When the GPS positioning is completed, press  to add speed camera point manually.
2. This product features a capacity of 50 speed cam positions. In case you are trying to add more than that the system prompts with message "**Speed Position is full**".



Note:

You may delete custom speed cam positions by selecting the *Delete Last Position* or *Delete All Position* option from the *Speed Position Management* menu. Please note that all of your existing speed cam positions are deleted once the *Delete All Position* option is selected. Make sure you are ready to recreate your custom speed cam positions before running this option.

3.3.3 Speed Limit Alert

If the **Speed Limit Alert** function is enabled, this product produces audible alert and screen message once your car's location is determined by GPS and its running speed exceeds the set limit.

To set the Speed Limit Alert, do the following:







1. Press the  button to enter the OSD menu.
2. Press the / button to select **Speed Limit Alert**, and then press the  button for entering function menu.
3. Press the /  button to set up a Speed Limit Alert to trigger this product's alarm [Off / 50 ~ 200 km/h (30~125 mph)], and then press the  button to complete setting.
4. Press the  button to return recording screen.
5. The screen pops up red icon to remind you to slow down when you are driving faster than the set speed limit.



3.3.4 Driver Fatigue Alert

If the **Driver Fatigue Alert** function is enabled, this product produces audible alert and screen message one hour after it has begun recording and repeats the alerts every half hour afterwards.

To enable the Driver Fatigue Alert, do the following:



1. Press the  button to enter the OSD menu.
2. Press the  button to select **Driver Fatigue Alert**, and then press the  button for entering function menu.
3. Press the  button to select **On**, and then press the  button to enable the function.
4. Press the  button return to recording screen.
5. This product produces audible alert and screen message when **Driver Fatigue Alert** activates.







3.3.5 LDWS

Once your car's location is determined by GPS and the **LDWS** function is enabled, this camcorder produces audible alert and screen message when you drive off of or change lanes at speeds over 70 km/h (43 mph).

To set the LDWS (Lane Departure Warning Systems), do the following:

1. Press the  button to enter the OSD menu.
2. Press the  button to select **LDWS**, and then press the  button for entering function menu.

- Press the  button to select **On**, and then press the  button to enable the function.
- Press the  button to return to recording screen.
- After enabling **LDWS**, the screen will display traffic lane align icon , please adjust the camcorder so that the horizontal line and the eye level are overlapped and the slash lines are centered in the driving lane.

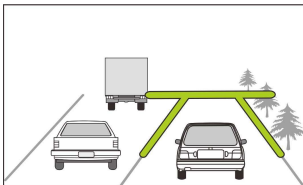

- This product produces audible alert and screen message when **LDWS** is activates.









Note:

- Please measure front windshield viewing area, do not block the driver's forward field of vision, and install the camcorder below rearview mirror (upper central of the front windshield). We recommend that the sky and the ground occupied 50 % of the video screen, install the bracket then adjust the camcorder to make the lane is aligned to the lane alignment icon. Correct installation makes the camcorder to maximize the efficiency and improve the accuracy of LDWS.
- Make sure that traffic lane align icon will not be obscured other things (e.g. hood). It may cause misjudgment if the endpoint is obscured.

3.3.6 FCWS

Once your car's location is determined by GPS and the **FCWS** function is enabled, this camcorder produces audible alert and screen message when you drive at speeds over 60 km/h (37 mph) and are less than 20m away from the car in front of you. If the camcorder not completes the satellite positioning, and the leading vehicle distance below 20 meters, it will also produce a warning screen and voice reminder.

To set the FCWS (Forward Collision Warning System), do the following:

1. Press the  button to enter the OSD menu.
2. Press the  button to select **FCWS**, and then press the  button for entering function menu.
3. Press the  button to select **On**, and then press the  button to enable the function.
4. Press the  button to return recording screen.
5. This product produces audible alert and screen message when **FCWS** is activates.









3.4 Parking Mode

To monitor the vehicle when it is parked, you can activate **Park Recording**, or **Motion and Collision Detection**, or **Timelapse**.

Before you activate Parking Mode, please install ACC cable through professional car service shop.

Follow the steps below to change the settings for Parking Mode:

1. Press the  button to enter the OSD menu.
2. Press the  button to select **Parking Mode**, and then press the  button for entering function menu.
3. Press the  button to configure Parking Mode (Park Recording / Motion and Collision Detection / Timelapse/ Off), and then press the  button to complete setting.
4. Press the  button to return recording screen.

Note: ACC cable is not included in the package. Please ask for more information from your distributor.

3.4.1 Park Recording

- In normal recording, press and hold **POWER** key for 3 seconds, the screen will show message **“Press OK key to power off or enter Park Recording after 10 sec.”** Please wait for 10 seconds and the camcorder will enter Park Recording automatically. The camcorder will turn off the screen temporarily, but still in recording status. Once the collision or vibration is detected, it will automatically trigger emergency recording.
- To disable this function, press any key to wake up the screen, and press again any key to resume to normal loop recording.

Note:

1. The video file taken in this mode is same as normal loop recording mode. It will be saved in the “Video” folder. And the emergency file will be saved in the “Emergency” folder.
2. The file size is according to Record Interval setting.

3.4.2 Motion and Collision Detection

- In normal loop recording mode, press and hold **POWER** key for 3 seconds, the screen will show message "**Press OK to power off or enter Motion and Collision Detection after 10 sec.**" Please wait for 10 seconds and the camcorder will enter Motion and Collision Detection automatically. The camcorder will turn off the screen temporarily, but still in standby detection status. When the camcorder detects any motion in front of lens or any vibration/collision, the video recording will be triggered and the event will be recorded.
- To disable this function, press any key to wake up the screen, and press again any key to resume to normal loop recording.

Note:

1. The video file taken in this mode will be saved in the "Emergency" folder.
2. In this mode, the event will be recorded for 10 seconds (per file). If the event lasts more than 10 seconds, the camcorder will keep recording up to 2 minutes.

3.4.3 Timelapse







- In normal loop recording mode, press and hold **POWER** key for 3 seconds, the screen will show message "**Press OK to power off or enter Timelapse after 10 sec.**" . Please wait for 10 seconds and the camcorder will enter Timelapse automatically. The camcorder will turn off the screen temporarily, but in timelapse recording status.
- To disable this function, press any key to wake up the screen, and press again any key to resume to normal loop recording.

Note:









1. The video file taken in this mode will be saved in the "Video" folder.
2. In this mode, the camcorder is continuously recording by one second one frame. For example, 30 minutes recording will be saved in one minute.
3. The file size is according to Record Interval setting.

3.5 Collision Detection

If the **Collision Detection** function is enabled, this camcorder begins emergency recording once it detects any collision. Sensitivity of the Collision Detection function is set to Normal by default, if user wants to change the settings of Collision Detection, do the following:

1. Press the  button to enter the OSD menu.
2. Press the  button to select **Collision Detection**, and then press the  button for entering function menu.
3. Press the  button to change the sensitivity of this camcorder's collision detection (High Sensitivity / Normal Sensitivity / Low Sensitivity / Off), and then press the  button for entering function menu.
4. Press the  button return to recording screen.

3.6 File Playback

1. Press the  button to enter the OSD menu.
2. Press the  button to select **Playback**, and then press the  button for entering function menu.
3. Press the  button to select **Video / Emergency / Picture**, and then press the  button for entering menu.
4. Press  button to browse the files, select the file and then press  button to enter **Playback Mode**. Press **Power** button to switch front and rear camera's recorded files.
5. Press the  repetitively to return recording screen.







3.7 Playback Screen





No.	Icon	Item	Description
1		File Number / Total File	Indicates of the total number of files.
2		Return Button	Press the button to return preview screen of video or picture. Press the button repetitively to return recording screen.
3		Previous File Button	Press button to view previous file.
4		Next File Button	Press button to view next file.
5		Playback/ Pause Button	Press the this button to play or pause the video.
6	HPIM180926-102056-000001F.MOV	File name	Indicates the file name of video / picture.
7	2020/01/01 12:00:00	Date and time	Indicates the date and time of film.
8	00:28/ 00:36	Playback Duration / Total Duration	Indicates video playback time and total duration.

3.8 Deleting Files

To delete file(s), perform the following steps:

1. Press the  button to stop recording and enter the main Menu.
2. Press the  or  button to select **File Deletion** and press the  button to confirm.
3. Press the  or  button to select folder and press the  button to confirm. The following options will display in screen,

Item	Description
Delete One	Delete the current selected file.
Delete All	Deletes all files in this folder.

4. Use the  or  to select the video or photo you want to delete, and press  button to confirm your selection.

Note:

1. Deleted files CANNOT be recovered. Ensure the files you wish to preserve are backup before deletion.
2. If the file is taken by front camera and rear camera at the same time, no matter you delete video or picture from Front camera folder or Rear camera folder, both front camera file and rear camera file will be deleted.

4 Initial set up Go Dashcam application

4.1 Camcorder application installation

The camcorder allows you to connect to the mobile devices via the App. When using for the first time, install the [Go Dashcam !] App for your mobile device.



1. Download **Go Dashcam !** App from Google Play or App Store.
2. Install the App.

APP layout and features may be changed subject to different software versions. Please refer to Google Play or APP Store for update.

4.2 Wi-Fi connecting

1. Press the **Power** button to switch on the camcorder.
2. Enter Menu and go to **Wi-Fi** option; choose “ON” to activate the wireless network.
3. The camcorder’s screen will display Wi-Fi Device ID and Password. Using the Wi-Fi function of your mobile device, search for the camcorder ID “hp_f920x_123456” from the list (last 6 numbers are system random numbers). Enter default password **12345678**.

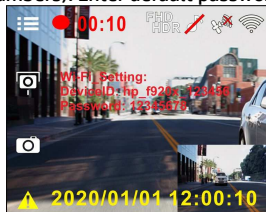

4. There is a Wi-Fi icon on the camcorder’s screen. Once the icon is blue, your connection has been successfully established.

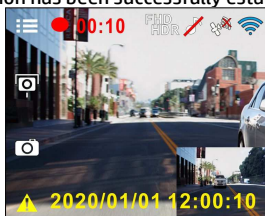

Note:

1. The mobile device shall be within a maximum of a 5m distance from the camcorder without any buildings in between.
2. When the Wi-Fi function of the camcorder is ON but not yet connecting with your mobile device, or the connection is disconnected, the Wi-Fi icon on camcorder’s screen will be white, and you will need to re-activate the Wi-Fi and re-pair with your mobile device.
3. After connecting the mobile device with the camcorder, and activate app feature “Camera Preview”, all the button operation of the camcorder will be disable; all the operations shall be carried out via the Go Dashcam ! App.
4. The language of the Go Dashcam ! App will be consistent with your mobile device, beyond the language options, the App will be activated with default language.

5 Using the Go Dashcam application



Tap [Go Dashcam !] icon to activate the application. The main screen will pop up. Follow the below instruction to operate this application.





5.1 Camera preview, record, snapshot

You can use this feature to preview, record or take snapshot.

1. The mobile device will display camcorder's preview screen. The camcorder will lose control and screen will show "Network Streaming". Please use Go Dashcam ! app to operate the camcorder.



	icon	Description
1		Start/stop recording
2		Snapshot (no matter in front camcorder or rear camcorder preview, once you touch this icon, both of front and rear camcorder will take photo.)
3		Switch front and rear camcorder preview





5.2 Playback, delete, download

You can use this feature to playback or delete the file saved in camcorder, or to download the file from camcorder to your mobile device.

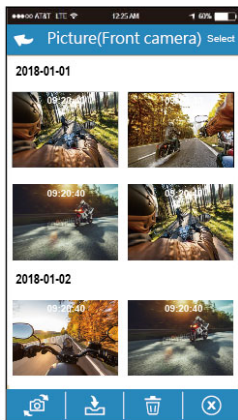
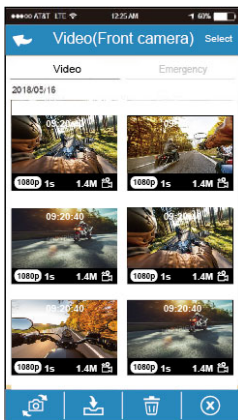

1. Tap the icon [Video playback] or [Picture playback].
2. The files saved in the camcorder will be displayed on your mobile device. Camcorder will stop recording for a few seconds until your mobile device finishes reading the saved files from camcorder, and screen will show "Network Playback".
3. Tap the preview image of video or picture to playback.
4. Tap the right top corner "Select" and pick up the files that you want to delete or download, and touch below icon to execute.



	Icon	Description
1		Switch front and rear camcorder
2		Download the file from camcorder to your mobile device
3		Delete
4		Exit

Note:

1. If you find the video playback without audio, please check if you turn on Voice Record on the menu. If you do turn it on, it means the mobile device itself doesn't support the video decoding. It's not the problem of the file. We recommend you to install a free app software such as VLC to playback the file.
2. Deleted files cannot be recovered. Ensure the files have been backed-up before deletion.
3. Picture and video files could be downloaded to the internal memory of your mobile device. Use the application program in your mobile device to view the file.
4. The downloaded videos or pictures will be saved in the album of your mobile device, at the mean time it will create a new folder "Go Dashcam!". You can preview the files from the album.

5.3 Local album

You can use this feature to playback or delete the file that you download to your mobile device.



1. Tap icon [Local Album] ◦
2. Pick up the file that you want to playback.
3. The downloaded videos or pictures will be saved in the album of your mobile device, at the mean time it will create a new folder “Go Dashcam !”. You can preview or delete the files from the album.



Note:

1. Deleted files cannot be recovered. Ensure the files have been backed-up before deletion.
2. If you find the downloaded files could not be played or without audio, which means the mobile device itself does not support the video decoding. It's not the problem of the file. We recommend you to install a free App software such as VLC to playback the file.

5.4 Camera Setting

You can use this feature to set up your car camcorder.









1. Tap icon [Camera Setting].
2. Refer to the below table for details of menu items and available menu options.

Menu option	Description	Available option
Resolution	Set the desired video resolution.	1080p 30fps HDR 1080p 27.5fps HDR 720p 30fps HDR 720p 27.5fps HDR
Record Interval	Save respective video files in a length of the selected duration.	30 sec / 1 min / 3 min
Voice Record	Setting for activating audio in the video.	On / Off
Time Stamp	If the time stamp is enabled, recording files or photos will show the date and time.	On / Off
Default	Return to factory default setting.	Yes / No
Format	To format the memory card, all the files in the camcorder will be deleted.	Yes / No
WiFi Setting	To set up Wi-Fi password	
Firmware Version	Indicates the current car camcorder's firmware version.	
App Version	Indicates the current application version.	

6 Adjusting the Settings

6.1 Using the Menu

You can customize the general settings via the on-screen display (OSD) menus.

1. Press the  button to enter the OSD menu.
2. Press the  button to select menu item, and then press the  button for entering function menu.
3. Press the  button to select or adjust the value, and then press the  button to confirm setting.
4. Press the  button to return recording screen.

6.2 Menu Items

Refer to the below table for details of main menu and function list.

Menu option	Description	Available option
Playback	Select the file category that you want to view.	Video Emergency Picture
Wi-Fi	Set up Wi-Fi linkage of a mobile phone.	On / Off
Satellite Status	Displays the current state of the satellite reception.	
Speed Unit	The system displays the speed setting unit.	KM/H / MPH
Speed Cam Alert	If the Speed Cam Alert function is enabled, once your car's location is determined by GPS and approaches a speed cam, this product produces audible alert and screen message.	On / Off

Menu option	Description	Available option
Speed Position Management	<p>Add Speed Point: The satellite positioning will manually add speed camera location. You can add up to 50 speed camera locations to the built-in system.</p> <p>Delete Last Position: Delete the last speed camera point.</p> <p>Delete All Position: Delete all speed camera point.</p>	Add Speed Point / Delete Last Position / Delete All Position
Speed Limit Alert	Set a customized maximum speed limit. When the vehicle speed exceeds the maximum, an audible alert is automatically triggered and a warning message is displayed on the screen.	Press the \triangle/∇ button to set the speed limit. You can set the off, or set speed limit from 50 to 200km/h (30 to 125mph)
Set Time Zone	Set the time zone you are in.	Press the \triangle/∇ button to set the satellite time. You may customize it between GMT -12 ~ GMT +14
Date / Time	Set the date and time.	Press the \triangle/∇ button to adjust the value, and then press the \odot/\mathbb{B} button to set the next field, and complete setting
Language	Language setting.	According to the actual shipping regions.
Resolution	Setting of video resolution.	1920x1080 30fps HDR 1920x1080 27.5fps HDR 1280x720 30fps HDR 1280x720 27.5fps HDR
EV	Setting of exposure value.	Press the \triangle/∇ button to set the exposure value. It can be set between -2 ~ +2

Menu option	Description	Available option
LCD Setting	Set LCD off time. Camcorder screen will be off after a set time if no operation is detected during the standby or record mode. Press any button will switch it on. (Recording is not affected when screen is off).	On/ Turn off after 7 sec / Turn off after 1min/ Turn off after 3min
Voice Record	Setting for activating audio in the video.	On / Off
Key Tone	Enable / disable power-on sound and key tone.	On / Off
Volume	Adjust the sound volume.	Press the \triangle/∇ button to set the volume. It can be set between 0 ~ 10.
Record Interval	Save respective video files in a length of the selected duration.	30 sec. / 1 min. / 3 min.
Parking Mode	If one of parking mode is activated, the camcorder will enter parking mode 10 seconds after disconnect the external power.	Off/ Park Recording / Motion and Collision Detection / Timelapse
Collision Detection	If Collision Detection is activated, this camcorder starts emergency recording once it detects any collision.	High Sensitivity / Normal Sensitivity / Low Sensitivity / Off
Driver Fatigue Alert	When Driver Fatigue Alert is enabled, audible alert and screen message will be activated 1 hour after the camcorder is powered on, with a repetition every 30 minutes.	On / Off

Menu option	Description	Available option
LDWS	Once your car's location is determined by GPS and the LDWS function is enabled, this camcorder produces audible alert and screen message when you drive off of or change lanes at speeds over 70 km/h (43 mph).	On / Off
FCWS	When FCWS is activated after satellite positioning, camcorder will issue audible alert and screen message when vehicle speed is above 60 km/h (37 mph) and the distance with the front vehicle is less than 20m.	On / Off
File Deletion	Delete the file(s).	Video Emergency Picture
Anti-flicker	Domestic power supply varies by area. It is recommended that you should check the "Table of voltage and frequency of different countries" for the correct setting.	60Hz / 50Hz
Format	Format the memory card inserted in the equipment. All the files in the card will be erased.	Yes / No
Default	The system reverts to the default setting.	Yes / No
Firmware Version	Indicates the current firmware version.	

7 SuperCar 2.0

Please download and install specific video/GPS player from this link,
https://ftp.digilife.com.tw/SuperCar_2.0/SuperCar_2.0.zip.



No.	Item
1	Front Camera Playback
2	Browse File
3	Capture
4	Fast Backward
5	Play / Pause
6	Fast Forward
7	Volume
8	Playback Duration

No.	Item
9	G-sensor Value
10	Rear Camera Playback
11	Software Version
12	Map
13	File List
14	Language and Map Change

Note:

- To display the route on Electronic Map, please make sure the internet is connected before starting the video playback.
- The SuperCar software is only applicable to Windows operating system.

8 Specifications

Item	Description
Image Sensor	1/2.8" Sony's Starvis CMOS sensor
Effective Pixels	1920 (H) x 1080 (V)
Storage Media	Support microSD class 10 and 16GB micro SD card (up to 128GB)
LCD Display	1.3" TFT LCD color screen
Lens	Wide Angle Fixed Focus lens F1.8
Focus Range	1.5m~Infinity
Satellite System	GPS
Movie Clip	Resolution: 1920x1080 30fps HDR 1280x720 30fps HDR 1920x1080 27.5fps HDR 1280x720 27.5fps HDR Format: TS
Still Image	Resolution: depends on video resolution setting Format: JPEG
Shutter	Electronic shutter
G-Sensor	3-Axis G-Force sensor
ISO	Auto
White Balance	Auto
Microphone	Yes
Speaker	Yes
Interface	Mini USB, A/V port

Item	Description
Power	Super Capacitor
Best Working Temperature	0° ~ 45° C
Operating Humidity	20 ~ 70% RH
Storage Temperature	-20° ~ 70° C
Dimensions	93.8 x 48.9 x 40 mm
Weight	Approx. 76g (without memory card)

Built-in IEEE 802.11g/n(HT20) Wi-Fi chip: RTL8188FTV

Frequency range	2412~2472MHz
Wi-Fi Channel	Ch1~Ch13
Wi-Fi Max. output	18dBm



f920x

**行車記錄器 (GPS)
使用說明書**

目錄

REGULATORY NOTICES	4
禁止同置	4
WEEE 通知.....	4
CE REGULATORY NOTICE	4
NCC 警語.....	5
安裝須知	5
安全注意事項.....	6
1 導論.....	8
1.1 功能	8
1.2 包裝內容	8
1.3 產品概要	9
2 開始.....	10
2.1 使用儲存媒體.....	10
2.1.1 插入記憶卡.....	10
2.1.2 取出記憶卡	10
2.2 安裝於車內.....	11
2.2.1 固定設備在擋風玻璃上	11
2.2.2 調整設備.....	12
2.3 置換支架	13
2.4 連接電源	14
2.5 LED 指示燈.....	14
2.6 設備開/關.....	15
2.6.1 自動開/關	15
2.6.2 手動開/關	15
2.6.3 重置設備.....	15

2.7	首次設定	15
2.7.1	設定時區.....	16
2.7.2	時間設定.....	17
3	使用行車記錄器.....	18
3.1	自動錄影	18
3.1.1	錄影畫面.....	19
3.1.2	緊急錄影.....	21
3.2	錄影中拍照.....	21
3.3	行車安全	22
3.3.1	測速照相提示	22
3.3.2	自訂測速點管理	23
3.3.3	自訂限速提示	24
3.3.4	駕駛休息提醒	24
3.3.5	車道偏移偵測	25
3.3.6	前車車距偵測	27
3.4	停車模式	27
3.4.1	停車錄影.....	28
3.4.2	移動與碰撞偵測	28
3.4.3	縮時錄影.....	29
3.5	碰撞偵測	30
3.6	播放影片及照片	30
3.7	播放畫面	31
3.8	檔案刪除	33
4	設定 GO DASHCAM 應用程式.....	34
4.1	下載安裝	34
4.2	Wi-Fi 連線.....	34

5	使用 GO DASHCAM 應用程式	36
5.1	相機預覽, 錄影及拍照	36
5.2	檔案播放, 刪除及下載	38
5.3	手機相簿	40
5.4	相機設定	42
6	調整設定	43
6.1	使用目錄	43
6.2	目錄選項	43
7	SUPERCAR 2.0	48
8	規格	49
9	限用物質含有情況說明書	52

有關本手冊

本文件之內容只供參考，並得以隨時變更不需要事先通知。本公司已盡全力確保本使用者手冊正確與完整。但有任何錯誤或遺漏概不負責。製造廠保留不需事先通知，逕自變更技術規格之權利。

Regulatory notices

This document provides country- and region-specific non-wireless and wireless regulatory notices and compliance information for your product. Some of these notices may not apply to your product.

禁止同置

本產品及其天線不得在同一地點與任何其他天線、發射器同置或共同操作。

WEEE 通知

歐盟有關使用者處分私人家庭廢電子與電機產品和/或電池之指令



WEEE



Battery

產品上或包裝上有此一符號，表示此產品不能做為家庭廢棄物處理。您必須依據相關之電子與電機產品和/或電池回收辦法之規定，處分您的廢電子與電機產品和/或電池。有關這類產品和/或電池的回收細節，請聯絡當地的市政府、您購買該產品的商店或您的家庭廢棄物處理公司。材料之回收有助於保護自然資源及確保能以保護人類健康與環境之方式回收。

CE Regulatory Notice

The product herewith complies with the requirements of the Low Voltage Directive 2014/35/EU, the EMC Directive 2014/30/EU, the RED-Directive 2014/53/EU and the RoHS Directive 2011/65/EU.

EU Health Protection: This equipment should be installed and operated with minimum distance 20cm between the radiator & your body.

NCC 警語

取得審驗證明之低功率射頻器材，非經核准，公司、商號或使用者均不得擅自變更頻率、加大功率或變更原設計之特性及功能。低功率射頻器材之使用不得影響飛航安全及干擾合法通信；經發現有干擾現象時，應立即停用，並改善至無干擾時方得繼續使用。前述合法通信，指依電信管理法規定作業之無線電通信。低功率射頻器材須忍受合法通信或工業、科學及醫療用電波輻射性電機設備之干擾。

本產品內含發射器芯片：RTL8188FTV



CCAM20LP2320T7

安裝須知

1. 請衡量前擋風玻璃的可視面積，以不遮擋駕駛前方的視野為原則，將本設備安裝在汽車後視鏡的正下方（前擋風玻璃中央偏上方的位置）。並建議天空與地面佔據錄影畫面各 **50%**，固定托架後再調整設備使車道對齊圖示與行駛車道對齊。正確的安裝可使設備發揮最大功效，並提升車道偏移偵測的準確性。
2. 確定鏡頭是在擋風玻璃雨刷的範圍內，確保視野良好，即使雨天依然清晰。
3. 不要用手指碰觸鏡頭。手指上的油垢可能會留在鏡頭上，導致影片或照片不清楚。請定期清潔鏡頭。
4. 請勿將本設備安裝在深色車窗上，否則將使隔熱紙受損。
5. 安裝設備之前請確認安裝位置不會受有色車窗阻礙。

6. 本產品僅適用於淺色擋風玻璃或貼附淺色隔熱紙的車窗，若使用深色車窗或車窗貼附有色隔熱紙，將影響錄影成像的效果。
7. 本設備僅適用產品隨附之電源連接器，請勿使用其他廠牌以免設備燒毀。

安全注意事項

- ❖ 使用者須遵守當地法律並以行車安全為優先考量，請勿於行車中操作本設備。
- ❖ 使用設備前請先確認時區、日期與時間已設定完成。
- ❖ **SuperCar** 軟體請在電子地圖正常運作的環境下使用。
- ❖ 本設備內建的軟體功能僅供使用者參考，道路駕駛請依實際路況作判斷。
- ❖ **GPS** 之定位結果僅供使用者參考，不應影響實際之駕駛行為，本設備無法確保其定位正確性。
- ❖ **GPS** 之定位正確性可能有所差異，包括受天候及使用地點（高樓 / 隧道 / 地下道 / 樹林）所影響，且 **GPS** 訊號無法穿透建築物及含金屬成份之汽車隔熱紙。
- ❖ **GPS** 收訊品質與個別硬體特性有所不同，本設備無法判斷因硬體差異所造成的不同定位結果。
- ❖ 本設備顯示之時速和方位等數值會因外在環境因素影響而有所誤差，僅供使用者參考。
- ❖ 本產品僅供使用於非商業用途，適用法律允許的最大限度內。本公司對於使用本產品所造成的損失不承擔任何責任。
- ❖ **Wi-Fi** 訊號無法穿透建築物，訊號距離上限為 5 公尺。
- ❖ **Wi-Fi** 運作頻道表：Ch1~Ch13.
- ❖ 本產品運用無線資料通訊，可能會干擾鄰近的裝置，或受臨近裝置所干擾。
- ❖ 請勿在微波爐附近或任何會產生磁波及無線電干擾之處使用本產品。

- ❖ 在特定環境下無線電波效果接收可能較差。
- ❖ 請注意若有其他裝置也使用本產品所使用的 **2.4GHZ** 頻段，則兩者的處理速度皆有可能變慢。
- ❖ 本設備在使用時會略微變熱，純屬正常現象不代表故障。
- ❖ 不正確地使用本產品或操作不當導致設備或配件損壞，您的保固將會無效。
- ❖ 本產品的射頻可能干擾其他電子設備發出的射頻，產生負面影響並造成故障狀況。無線發射器和電路亦可能會干擾到其他電子設備，因此請遵守下列注意事項：
 - 飛機：當您搭乘飛機時，禁止使用無線發射器，請您關閉本產品的 **Wi-Fi** 功能。
 - 車輛：本產品發出的射頻可能會影響機動車輛中的電子系統，請您與該機動車的製造商或代理商洽詢車輛的問題。
 - 心律調節器：為避免對心律調節器造成潛在性的干擾，配戴心律調節器的人士應注意裝置啟用時，本產品與心律調節器之間的距離應保持在 **15 公分 (6 英寸)** 以上，並且請勿將本產品置於胸前口袋。若懷疑發生干擾現象時，請立即將本產品電源關閉。
 - 醫療裝置：若您使用任何個人醫療裝置，請詢問裝置製造商或醫生，確認您的裝置是否可充分屏蔽本產品發出的射頻。
 - 醫療機構：醫院和醫療機構可能使用對外部射頻能量敏感的設備，當醫療人員或張貼的標誌指示您關閉會干擾射頻的設備時，請遵守指示。
 - 爆破區域與張貼告示的場所：若要避免干擾爆破作業，請在“爆破區域”或標示“關閉雙向無線電”的區域裡，遵守所有的標誌與指示關閉會干擾射頻的設備。
- ❖ **HP Inc.**對於操作中任何資料／內容的損失概不負責。

開始使用本產品視為同意以上聲明事項。

1 導論







謝謝惠顧此套先進的行車記錄器(以下簡稱“設備”)。本產品專用於行車時之即時錄影。本機種支援惠普高清後置鏡頭，可洽經銷商選購，保障您的行車安全。

1.1 功能

- 超高畫質錄影 (1920x1080P@30fps)
- 1.3” 彩色螢幕
- 廣角鏡頭
- 碰撞偵測，設備感測到碰撞即自動觸發緊急錄影
- 停車監控
- 多功能行車安全提醒

1.2 包裝內容

以下為包裝內容物。若有任何遺漏或損壞項目，請立即聯絡您的經銷商。

行車記錄器	背膠支架	靜電貼	托架
			
快速使用手冊	電源連接器	後置鏡頭 (選配)	
			

1.3 產品概要

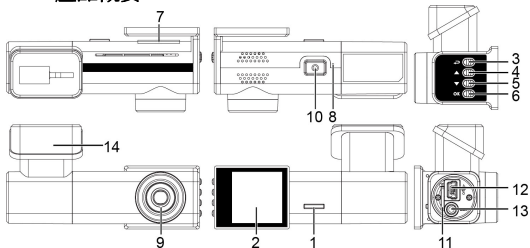

編號	項目
1	LED 指示燈
2	螢幕
3	目錄/返回按鍵 (☰ / ↶)
4	新增測速點/向上按鍵 (📍 / ▲)
5	影片截圖/向下按鍵 (📷 / ▼)
6	緊急錄影/確認按鍵 (⚠️ / 🎧)
7	喇叭

編號	項目
8	麥克風
9	廣角鏡頭
10	電源開關
11	記憶卡插槽
12	電源連接孔
13	後置鏡頭連接埠 (選配)
14	托架插孔

2 開始

2.1 使用儲存媒體

2.1.1 插入記憶卡

將記憶卡之金色接腳面朝前，以及設備螢幕面朝前，如圖示插入記憶卡。

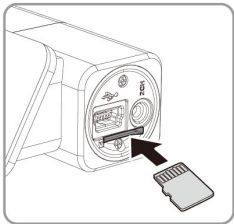

2.1.2 取出記憶卡

若設備在開機狀態請先關閉電源，並等待設備完成關機程序後再取出記憶卡。

備註：

1. 設備在開機狀態時，不要取出或插入記憶卡，以免損壞記憶卡。
2. 限使用 **microSD** 速度等級 **10** 以上，且記憶體容量 **16GB** 以上的 **micro SD** 卡(最高支援 **128GB**)。
3. 使用前請使用本紀錄器先格式化 **micro SD** 卡。
4. 請定期格式化記憶卡(建議一個月一次)。

2.2 安裝於車內

2.2.1 固定設備在擋風玻璃上

1. 安裝在下圖所示建議區域的擋風玻璃上，安裝前請將玻璃擦拭乾淨。

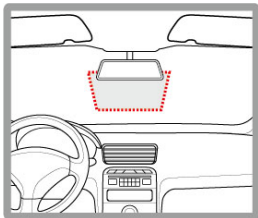

2. 將托架基座推入設備上方的托架插孔中，直到聽到咔嗒聲固定。

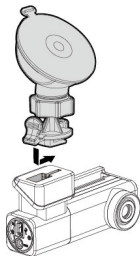

3. 用酒精擦拭托架的吸盤及擋風玻璃至乾淨，並等待酒精乾透。將托架的吸盤輕壓於擋風玻璃上，再按下托架的夾子固定托架。
4. 確認托架已牢牢固定。

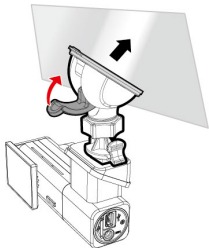

2.2.2 調整設備

1. 鬆開旋鈕，將設備垂直或水平方向調整。。

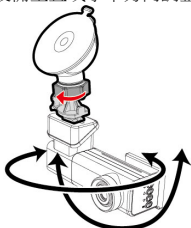

2. 鎖緊旋鈕，並確認設備已牢牢固定。

2.3 置換支架

1. 將設備上的T型支架往下推出。
2. 拆下支架之後，可以看到兩個凹槽和一個向上的箭頭。
3. 欲置換的背膠支架的箭頭也要向上，翻轉背膠支架準備扣上。
4. 將背膠支架的兩個倒鉤放入凹槽，再向上推直到聽到咔嗒聲固定。

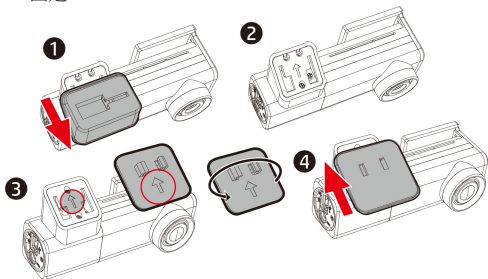

備註:

使用背膠支架安裝於車內時，請先將靜電貼安裝在建議區域的擋風玻璃上，安裝前請將玻璃擦拭乾淨，安裝時請將靜電貼與玻璃之間的氣泡擠壓乾淨。撕下背膠支架的離形紙，將支架黏貼於擋風玻璃上，輕壓並確認支架已固定。

2.4 連接電源

限使用產品隨附之電源連接器啟動設備。

1. 將電源連接器的一端連接到設備的電源連接埠。電源連接埠輸入直流電壓 $5V / 2A$ 。
2. 將電源連接器的另一端插接汽車內的香煙點火器插孔。汽車引擎一旦發動，設備即自動開機。車充輸入直流電壓 $12 / 24V$ 。

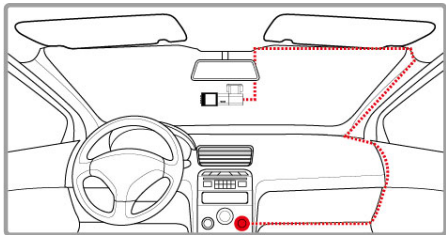

備註：

本設備僅適用產品所附之電源連接器，請勿使用其他廠牌以免設備燒毀。

2.5 LED 指示燈

狀態說明	LED 指示燈顏色
未開機 插入外部電源	紅燈
開機 待機中	綠燈
錄影中 / 錄影中且螢幕關閉	紅燈閃爍

2.6 設備開/關

2.6.1 自動開/關

汽車引擎發動之後，等待數秒自動為行車記錄器充電，數秒後將自動開機並啟動錄影。汽車引擎一旦熄火，設備會自動儲存記錄並關閉電源。

備註：

本行車記錄器使用超級電容，因此汽車引擎發動之後，需等待數秒為內建超級電容充電，數秒後記錄器便會自動開機並啟動錄影。

2.6.2 手動開/關

按下**電源開關**按鍵以手動方式打開電源。

按住**電源開關**按鍵至少 2 秒關掉電源。

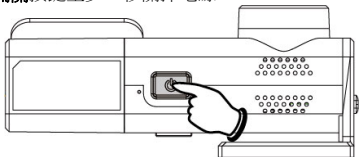

2.6.3 重置設備

按住**電源開關**按鍵至少 8 秒重新設定。

2.7 首次設定







在使用設備之前，我們建議先設定正確的**時區、日期與時間**。

備註：

請注意若在錄影期間按  按鍵，系統將會停止錄影並進入 OSD 目錄。請先確認錄影可以中止再操作目錄選單。

2.7.1 設定時區

設定正確的時區，其方式如下：







1. 按  按鍵，進入 OSD 目錄。
2. 按  按鍵選擇**設定時區**，再按  按鍵進入功能選單。
3. 按  設定目前所在的時區，再按  按鍵完成設定。
4. 按  返回錄影畫面。

備註：若衛星無法定位完成，設備時間會依使用者自訂時間為基準。

City	UTC	City	UTC	City	UTC	City	UTC	City	UTC
Accra	0	Budapest *	+1	Houston *	-6	Melbourne	+10	Santiago	-4
Addis Ababa	+3	Buenos Aires	-3	Indianapolis *	-5	Mexico City *	-6	Santo Domingo	-4
Adelaide **	+9	Cairo	+2	Islamabad	+5	Miami *	-5	São Paulo	-3
Algiers	+1	Calgary *	-7	Istanbul *	+2	Minneapolis *	-6	Seattle *	-8
Almaty	+6	Camberra	+10	Jakarta	+7	Minsk	+3	Seoul	+9
Amman *	+2	Cape Town	+2	Jerusalem *	+2	Montevideo	-3	Shanghai	+8
Amsterdam *	+1	Caracas **	-4	Johannesburg	+2	Montreal *	-5	Singapore	+8
Anadyr	+12	Casablanca *	0	Kabul **	+4	Moscow	+4	Sofia *	+2
Anchorage *	-9	Chicago *	-6	Karachi	+5	Mumbai **	+5	St. John's **	-3
Ankara *	+2	Columbus *	-5	Kathmandu **	+5	Nairobi	+3	Stockholm *	+1
Antananarivo	+3	Copenhagen *	+1	Khartoum	+3	Nassau *	-5	Suva	+12
Asuncion	-4	Dallas *	-6	Kingston	-5	New Delhi **	+5	Sydney	+10
Athens *	+2	Dar es Salaam	+3	Kinshasa	+1	New Orleans *	-6	Taipei	+8
Atlanta *	-5	Darwin **	+9	Kiritimati	+14	New York *	-5	Tallinn *	+2
Auckland	+12	Denver *	-7	Kolkata **	+5	Oslo *	+1	Tashkent	+5
Baghdad	+3	Detroit *	-5	Kuala Lumpur	+8	Ottawa *	-5	Tegucigalpa	-6
Bangalore	+5	Dhaka	+6	Kuwait City	+3	Paris *	+1	Tehran **	+3
Bangkok	+7	Doha	+3	Kyiv *	+2	Perth	+8	Tokyo	+9
Barcelona *	+1	Dubai	+4	La Paz	-4	Philadelphia *	-5	Toronto *	-5
Beijing	+8	Dublin *	0	Lagos	+1	Phoenix	-7	Vancouver *	-8
Beirut *	+2	Edmonton *	-7	Lahore	+5	Prague *	+1	Vienna *	+1
Belgrade *	+1	Frankfurt *	+1	Las Vegas *	-8	Reykjavik	0	Warsaw *	+1
Berlin *	+1	Guatemala	-6	Lima	-5	Rio de Janeiro	-3	Washington DC *	-5
Bogota	-5	Halifax *	-4	Lisbon *	0	Riyadh	+3	Winnipeg *	-6
Boston *	-5	Hanoi	+7	London *	0	Rome *	+1	Yangon **	+6
Brasilia	-3	Harare	+2	Los Angeles *	-8	Salt Lake City *	-7	Zagreb *	+1
Brisbane	+10	Havana *	-5	Madrid *	+1	San Francisco *	-8	Zürich *	+1
Brussels *	+1	Hong Kong	+8	Managua	-6	San Juan	-4		
Bucharest *	+2	Honolulu	-10	Manila	+8	San Salvador	-6		

2.7.2 時間設定

設定正確的日期與時間，其方式如下：

1. 按  按鍵，進入 OSD 目錄。
2. 按  /  按鍵選擇**時間設定**，再按  按鍵進入功能選單。
3. 按  /  按鍵調整數值，再按  按鍵切換到下一個欄位。
4. 重複步驟 3，直到日期與時間完成設定。



備註：

為確保錄影檔案時間的正確性，超過7天未使用設備時，需重新設定日期與時間。

3 使用行車記錄器

3.1 自動錄影

汽車引擎發動之後，等待數秒自動為行車記錄器充電，數秒後將自動開機並啟動錄影。

當引擎熄火時設備會自動停止錄影。

備註：

1. 某些汽車的車用電源並不會隨著汽車引擎的發動/熄火而自動開啟/關閉電源，若設備無法隨汽車引擎自動開啟與關閉電源時，請以手動方式將電源連接器與車用電源連接，再開啟設備電源，或是以手動方式關閉設備的電源，再將電源連接器從車用電源卸除。
2. 可設定每個影片檔案錄影的時長為30秒, 1 或 3 分鐘。
3. 設備會儲存影片或照片於記憶卡中，若記憶卡空間已滿時，循環錄影會將一般錄影中最舊的檔案覆蓋掉。
4. 本行車記錄器使用超級電容，因此汽車引擎發動之後，需等待數秒為內建超級電容充電，數秒後記錄器便會自動開機並啟動錄影。

3.1.1

錄影畫面

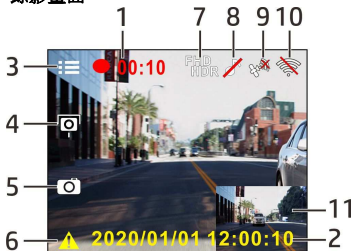

編號	圖示	項目	說明
1	 00:10	錄影時長	當前的錄影時長。
2	2020/01/01 12:00:00	日期與時間	當前拍攝的日期與時間。
3		目錄按鍵	1.在錄影期間按  按鍵可進入 OSD 目錄。 2.長按3秒進入快顯二宮格,可立即查看目前方位及時速。
4		新增自訂測速點按鍵	在錄影期間按  按鍵可新增自訂的測速點。

編號	圖示	項目	說明
5		影片截圖 按鍵	在錄影期間按  按鍵可擷取錄影畫面。
6		緊急錄影 按鍵	在錄影期間按  按鍵可進入緊急錄影模式。
7		影像解析 度 圖示	當前的影像解析度。
8		聲音記錄 圖示	聲音記錄設定為關閉的狀態，拍攝影片時將不會錄音。
9		衛星定位 圖示	指示衛星定位的信號狀態。若圖示顯示X，則表示設備無法完成衛星定位。
10		Wi-Fi	 表示Wi-Fi開啟  表示Wi-Fi關閉
11		子母畫面	呈現後鏡頭的錄影畫面。(僅示意本機可支援後置高清鏡頭，包裝中並無附贈，欲瞭解更多資訊，請洽經銷商諮詢。)

3.1.2 緊急錄影

啟動緊急錄影，其方式如下：

1. 在錄影期間按 **OK** 按鍵將會進入**緊急錄影模式**，並於螢幕左上角顯示 "**緊急錄影**" 的字樣。在緊急錄影模式中錄製的影片會被保護起來。
2. 緊急錄影的時長同錄影間隔的設定。當緊急錄影達設定的時間，系統會回復到一般的錄影模式。



備註：

1. 若啟動 **碰撞偵測** 功能並偵測到碰撞，設備會自動進入緊急錄影模式。
2. 此時會建立新的緊急錄影檔，並且儲存在緊急錄影資料夾，此檔案會受到保護避免被一般循環錄影所覆寫。緊急錄影資料夾約占**40%**的記憶卡容量。例如，容量**8GB**的記憶卡，可以儲存大約**3.2GB**的緊急錄影檔。緊急錄影檔已滿時，當新的緊急錄影檔建立，最舊的緊急錄影檔會被自動刪除。

3.2 錄影中拍照

您可以使用本設備拍攝現場。

1. 請於錄影期間按 **▽** 按鍵擷取錄影畫面。
2. 當螢幕中央顯示 **📸** 圖示，表示前鏡頭的錄影畫面已擷取完成。



備註：

- 1.錄影中擷取的照片尺寸取決於影像解析度的設定。
- 2.行駛中若執行錄影中拍照，其照片的清晰度可能會受限於標的物的移動速度與外在環境光源的變化，因此拍照功能較適用於事故發生時或路口紅綠燈停駛時，採用靜態的方式拍照存查。

3.3 行車安全

下列的行車安全功能僅提供參考，道路駕駛請依實際路況作判斷。





備註：

- 1.行車安全的各項功能無法同時觸發兩項以上的警示，若設備已觸發語音與警示畫面，在當下警示未停止之前，其他的語音與警示畫面會被忽略。
- 2.設備必須在衛星定位已完成的狀態下才能作用*測速照相提示*、*自訂測速點管理*、*自訂限速提示*、*車道偏移偵測*與*前車車距偵測*，使用前請確認設備的衛星定位已完成。
- 3.在陰雨、夜晚或光線不足的環境下啟用*車道偏移偵測*或*前車車距偵測*等功能，設備可能會發生誤判，道路駕駛請依實際路況作判斷。

3.3.1 測速照相提示

若啟用**測速照相提示**，當衛星定位完成且車輛接近測速照相機時，設備會發出語音與警示畫面提醒。

啟動測速照相提示，其方式如下：

1. 按  按鍵，進入 OSD 目錄。
2. 按  按鍵選擇**測速照相提示**，再按  按鍵進入功能選單。
3. 按  按鍵選擇“開”，再按  按鍵啟用該功能。

- 按  返回錄影畫面。
- 若警示畫面顯示為紅色，表示行車時速已超過該路段的限速，提醒道路駕駛應減速慢行。



備註：

測速照相提示的功能必須具有該國或該地區的測速照相圖資，若至其他國家或地區使用，可能會造成此功能無法作用。本產品不保證測速照相的圖資包含您所在的國家，若此功能無法使用請與當地經銷商確認。

3.3.2 自訂測速點管理

您可以使用本設備自行設定測速照相點。

- 當衛星定位完成後，在錄影期間按  按鍵可新增自訂的測速照相點。
- 本設備最多可新增 50 筆自訂測速點，當超過 50 筆自訂測速點時，螢幕會顯示 "**測速點已滿**"。

備註：

若設備新增的自訂測速點已滿，請至 **自訂測速點管理** 功能選單中選擇 **刪除最後一筆** 或 **刪除全部測速點**。請注意一旦執行 **刪除全部測速點**，系統會將所有已建立的自訂測速點全部刪除，故執行前請確認是否要將自訂測速點重新設定。

3.3.3 自訂限速提示

若啟用**自訂限速提示**，當衛星定位完成且車速超過設定值，設備會發出警示音與警示畫面提醒。

設定自訂限速提示，其方式如下：



1. 按  按鍵，進入 OSD 目錄。
2. 按  按鍵選擇**自訂限速提示**，再按  按鍵進入功能選單。
3. 按  按鍵自訂本設備發出警示的限速 [關 / 50 ~ 200 km/h (30~125 mph)]，再按  按鍵完成設定。
4. 按  返回錄影畫面。
5. 行駛中，若出現警示畫面及警示音，表示行車時速已超過自訂的限速，提醒道路駕駛應減速慢行。





3.3.4 駕駛休息提醒

若啟用**駕駛休息提醒**，當開機錄影達 1 小時設備會發出警示音與警示畫面提醒，並每隔三十分鐘重複警示。

啟動駕駛休息提醒，其方式如下：

1. 按  按鍵，進入 OSD 目錄。
2. 按  按鍵選擇**駕駛休息提醒**，再按  按鍵進入功能選單。







3. 按  按鍵選擇“開”，再按  按鍵啟用該功能。
4. 按  返回錄影畫面。
5. 當**駕駛休息提醒**觸發時，設備會發出警示音與警示畫面提醒。



3.3.5 車道偏移偵測

若啟用**車道偏移偵測**，當衛星定位完成後，行車時速達 70 km/h (43 mph) 以上且偏離行駛車道或變換車道時，設備會發出語音與警示畫面提醒。

設定車道偏移偵測，其方式如下：

1. 按  按鍵，進入 OSD 目錄。
2. 按  按鍵選擇**車道偏移偵測**，再按  按鍵進入功能選單。
3. 按  按鍵選擇“開”，再按  按鍵啟用該功能。
4. 按  返回錄影畫面。

5. 啟用**車道偏移偵測**後，螢幕中央會顯示車道對齊圖示。請調整設備使車道對齊圖示的水平線與路面視平線水平重疊；車道對齊圖示的兩側斜線居中於行駛車道。

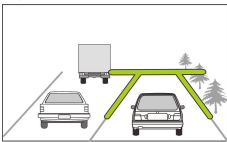

6. 當**車道偏移偵測**觸發時，設備會發出語音與警示畫面提醒。









備註：

- 1.請衡量前擋風玻璃的可視面積，以不遮擋駕駛前方的視野為原則，將本設備安裝在汽車後視鏡的正下方(前擋風玻璃中央偏上方的位置)。並建議天空與地面佔據錄影畫面各**50%**，固定托架後再調整設備使車道對齊圖示與行駛車道對齊。正確的安裝可使設備發揮最大功效，並提升車道偏移偵測的準確性。
- 2.請確認車道對齊圖示不會被其他的物體遮蔽(如：引擎蓋)。若車道對齊圖示的端點被遮蔽，將會造成系統誤判。

3.3.6 前車車距偵測

若啟用**前車車距偵測**，當衛星定位完成後行車時速達 60 km/h (37 mph) 以上且與前方車距低於 20 公尺時，設備會發出語音與警示畫面提醒。若設備未完成衛星定位，且與前方車距低於 20 公尺時，亦會發出語音與警示畫面提醒。

設定前車車距偵測，其方式如下：







1. 按  按鍵，進入 OSD 目錄。
2. 按  按鍵選擇**前車車距偵測**，再按  按鍵進入功能選單。
3. 按  按鍵選擇“開”，再按  按鍵啟用該功能。
4. 按  返回錄影畫面。
5. 當**前車車距偵測**觸發時，設備會發出語音與警示畫面提醒。



3.4 停車模式

若啟用**停車錄影**、**移動與碰撞偵測**或**縮時錄影**，可透過本設備監控車輛停置時的狀況。

啟用停車模式之前，請您經由專門店安裝**ACC常時電源線**。

1. 按  按鍵，進入 OSD 目錄。
2. 按  按鍵選擇 **停車模式**，再按  按鍵進入功能選單。
3. 按  按鍵設置停車模式 (**停車錄影/ 移動與碰撞偵測/ 縮時錄影/ 關**)，再按  按鍵完成設置。
4. 按  返回錄影畫面。

備註：本包裝不包含ACC常時電源線，如欲購買，請洽經銷商。

3.4.1 停車錄影

- 一般錄影狀態下，長按電源鍵 3秒，螢幕會出現“**按OK鍵將關機或10秒後進入停車錄影**”。請等待10秒，記錄器會自動進入停車錄影模式。此時，記錄器會暫時關閉螢幕，處於持續錄影狀態，但遇到碰撞或震動，會啟動緊急錄影。
- **【解除】**若要解除此模式，按任意鍵喚醒螢幕，再按一次任意鍵返回一般錄影。

備註：

1. 此模式的錄影檔案與一般循環錄影模式相同，會儲存在一般錄影資料夾。緊急錄影則儲存於緊急錄影資料夾。
2. 檔案大小依錄影間隔設定而定。

3.4.2 移動與碰撞偵測

- 一般錄影狀態下，長按電源鍵 3秒，螢幕會出現“**按OK鍵將關機或10秒後進入移動與碰撞偵測**”。請等待10秒，記錄器會自動進入**移動與碰撞偵測**模式。此時，記錄器會暫時關

閉螢幕，處於待機偵測狀態。遇到鏡頭前方有物體移動或碰撞震動，會啟動錄影。

- **【解除】**若要解除此模式，按任意鍵喚醒螢幕，再按一次任意鍵返回一般錄影。

備註：

1. 此模式的錄影檔案會儲存在緊急錄影資料夾。
2. 在此模式下，啟動錄影10 秒鐘儲存一個檔案，若記錄器仍偵測到異常會以 10 秒鐘為單位持續錄影，單筆錄像最長可達 2 分鐘。

3.4.3 縮時錄影







- 一般錄影狀態下，長按電源鍵 3秒，螢幕會出現“**按OK鍵將關機或10秒後進入縮時錄影**”。請等待10秒，記錄器會自動進入縮時錄影。此時，記錄器會暫時關閉螢幕，處於縮時錄影狀態。
- **【解除】**若要解除此模式，按任意鍵喚醒螢幕，再按一次任意鍵返回一般錄影。

備註：

1. 檔案儲存於一般錄影的資料夾。
2. 在此模式下，記錄器是以一秒鐘一幀的格式錄影，例如，30 分鐘實際錄下來的檔案時長是 1 分鐘。
3. 檔案大小依錄影間隔設定而定。

3.5 碰撞偵測

若啟用**碰撞偵測**，當設備感測到碰撞時會自動啟動緊急錄影。碰撞偵測預設為中靈敏度，若要變更碰撞偵測的設定，請依循以下步驟：

1. 按  按鍵，進入 OSD 目錄。
2. 按  按鍵選擇**碰撞偵測**，再按  按鍵進入功能選單。
3. 按  按鍵設定本設備感測碰撞的靈敏度（高靈敏度 / 中靈敏度 / 低靈敏度 / 關），再按  按鍵進入功能選單。
4. 按  返回錄影畫面。

3.6 播放影片及照片

1. 按  按鍵，進入 OSD 目錄。
2. 按  按鍵選擇**播放**，再按  按鍵進入功能選單。
3. 按  按鍵選擇**錄影 / 緊急錄影 / 照片**，再按  按鍵進入選單。
4. 按  按鍵瀏覽檔案，選擇檔案後再按  按鍵確認播放該檔案。或是按**電源鍵**切換前後鏡頭拍攝檔案。
5. 重複按  按鍵返回錄影畫面。



3.7 播放畫面



編號	圖示	項目	說明
1	1/30	檔案編號 / 檔案總數	檔案的編號與總數。
2		返回按鍵	返回影片或照片的預覽畫面，重複按  按鍵可返回錄影畫面。
3		上一個檔案按鍵	切換到上一個檔案。
4		下一個檔案按鍵	切換到下一個檔案。



編號	圖示	項目	說明
5		播放 / 暫停按鍵	播放或暫停影片。
6	HPIM180926-102056 -000001F.MOV	檔案名稱	影片 / 照片的檔案名稱。
7	2020/01/01 12:00:00	日期與時間	指示拍攝的日期與時間。
8	00:28 / 00:36	播放時長 / 總時長	影片播放的時間與總時長。

3.8 檔案刪除

進行下列步驟刪除檔案：

1. 如果正在錄影中，按下  按鍵停止錄影並進入設定選單。
2. 按  或  按鍵選擇 **檔案刪除** 選項並按下  按鍵。
3. 按  或  按鍵選擇欲刪除的資料夾並按下  按鍵。
出現以下選擇，按下  按鍵確認。

項目	說明
刪除單檔	刪除所選的檔案。
刪除所有檔案	刪除此資料夾所有檔案。

4. 按  或  按鍵選擇要刪除的影片或照片檔案並按下  按鍵確認刪除。

備註：

1. 刪除的檔案不能復原。刪除前確定想保存的檔案有備份。
2. 同時使用前後鏡頭拍照或錄影，所儲存的檔案，無論您只刪除前鏡頭檔案或是只刪除後鏡頭檔案，兩個前後鏡頭的檔案都會同時被刪除。

4 設定 Go Dashcam 應用程式

4.1 下載安裝

此行車記錄器可透過應用程式連線到您的行動裝置。初次使用請先為您的行動裝置安裝 **[Go Dashcam !]** 應用程式。

1. 從網路 Google Play 或 App Store 下載 **Go Dashcam !**



應用程式。

2. 完成安裝。

應用程式的介面和功能可能會因應用程式版本的不同而改變，詳情請參訪 **Google Play** 或 **APP Store** 的更新。

4.2 Wi-Fi 連線

1. 按下行車記錄器的**電源**按鈕開啟電源。
2. 進入主目錄的 **Wi-Fi** 選項，選擇**ON**，開啟無線網路。
3. 記錄器螢幕會顯示Wi-Fi識別碼及密碼，使用行動裝置的Wi-Fi 功能搜尋清單中的行車記錄器識別碼：**hp_f920x_123456**（後六碼為隨機識別碼），輸入**預設密碼 12345678**。

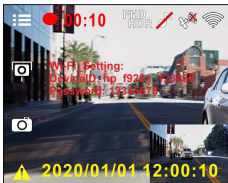

4. 記錄器螢幕的Wi-Fi符號變成藍色，表示已完成配對連線成功。

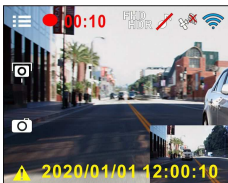

備註：

1. 行動裝置與記錄器連線需在 5 公尺以內，並且沒有建築物阻隔。
2. 當記錄器的 Wi-Fi 功能開啟，若一直未與您的行動裝置連線，記錄器螢幕會顯示白色的Wi-Fi符號。欲再次連線，請重新開啟行動裝置的 Wi-Fi並配對。
3. 當行動裝置與記錄器連線之後，點選並開啟[Go Dashcam!]應用程式，記錄器的操作按鈕將失去作用，記錄器的螢幕會顯示“Network Streaming”，請透過 [Go Dashcam!] 應用程式進行操作。
4. [Go Dashcam!] 應用程式的語言將與您的行動裝置一致，非內建語言則為預設。

5 使用 Go Dashcam 應用程式



觸碰行動裝置的 Go Dashcam 圖示，開啟應用程式，出現主畫面，請依照以下步驟進行設定或操作。

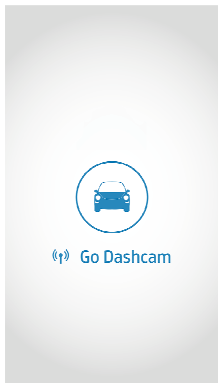



5.1 相機預覽，錄影及拍照

您可以使用此功能預覽行車記錄器的畫面，啟動錄影或是拍照。

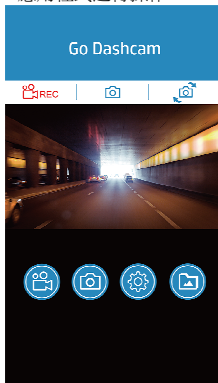
1. 行動裝置螢幕會顯示記錄器的預覽畫面。記錄器的操作按鈕將失去作用，記錄器的螢幕會顯示“Network Streaming”，請透過Go Dashcam 應用程式進行操作。





	圖示	敘述
1		錄影/暫停錄影
2		拍照 (無論是前鏡頭預覽或是後鏡頭預覽，按下拍照鍵，前後鏡頭都會拍照)
3		切換前後鏡頭預覽

5.2 檔案播放，刪除及下載

您可以使用此功能播放或刪除行車記錄器拍攝的照片與影片，或是下載其照片與影片到您的行動裝置。



1. 觸碰主畫面下方的  【影片播放】 或  【照片播放】。
2. 行動裝置螢幕會顯示行車記錄器儲存的檔案清單。行車記錄器將暫停錄影數秒，直到行動裝置讀取完記錄器內儲存的檔案，記錄器的螢幕會顯示 **"Network playback"**。
3. 直接點選該影片或是照片，進行播放。
4. 若要刪除或下載，觸碰畫面右上方的"選取"，點選所需的影片或是照片，再點選下方圖標執行刪除或下載檔案。

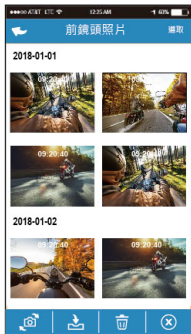
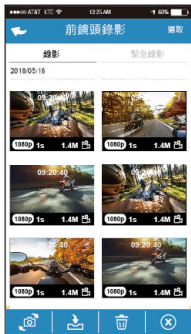

	圖示	敘述
1		切換前後鏡頭檔案
2		下載檔案到行動裝置
3		刪除檔案
4		退出選單

備註：

1. 若播放影片時，無法播放聲音，請檢查目錄設定是否開啟錄音功能，若已開啟錄音功能，表示該行動裝置不支援影音解碼並非檔案問題。如欲觀賞完整的影音，請將檔案下載至您的行動裝置，並為行動裝置安裝其它的影音應用程式，如VLC.....等，以播放下載的影片。
2. 刪除的檔案不能回復。刪除前請確保檔案留有備份。
3. 同時使用前後鏡頭拍照或錄影，所儲存的檔案，無論您只刪除前鏡頭檔案或是只刪除後鏡頭檔案，兩個前後鏡頭的檔案都會同時被刪除。
4. 下載的照片和影片會儲存在您的行動裝置的相簿，同時產生一個“Go Dashcam”的資料夾，您可以在該資料夾瀏覽檔案。

5.3 手機相簿



1. 觸碰主畫面下方的 [手機相簿]。
2. 點選欲播放的影片或是照片執行播放。



3. 下載的照片和影片會儲存在您的行動裝置的相簿，同時產生一個“Go Dashcam”的資料夾，您可以在該資料夾瀏覽檔案。若要刪除該檔案，可在您行動裝置的相簿內刪除。

備註：

1. 刪除的檔案不能回復。刪除前請確保檔案留有備份。
2. 若下載至行動裝置的影片檔案播放時沒有影音，表示該行動裝置不支援影音解碼並非檔案問題。建議您可以為行動裝置安裝其它的影音應用程式，如VLC.....等，以播放下載的影片。

5.4 相機設定

您可以使用此功能設定行車記錄器。









1. 觸碰主畫面下方的 **[相機設定]**。
2. 可用選單如表，請依個人需求或喜好進行設定。

目錄選項	描述	可用選單
影像解析度	設定所需的影像解析度。	1080p 30fps HDR 1080p 27.5fps HDR 720p 30fps HDR 720p 27.5fps HDR
錄影間隔	設備依循您所設定的影片長度將錄製的影片儲存為各個檔案。	30秒 / 1分鐘 / 3分鐘
聲音紀錄	設定錄影時是否錄音。	開 / 關
時間標記	若啟用時間標記，拍攝下來的影片或照片將會顯示日期與時間。	開 / 關
回復原廠設置	將系統回復到出廠的設定。	是 / 否
格式化	將設備中的記憶卡格式化，所有的檔案都將喪失。	是 / 否
連線設定	設定連線密碼。	
韌體版本	顯示行車記錄器當前韌體版本。	
APP 版本	顯示當前 APP 版本。	

6 調整設定

6.1 使用目錄

您可以透過螢幕顯示的目錄自訂常規設定。

1. 按  按鍵，進入 OSD 目錄。
2. 按  按鍵選擇目錄選項，再按  按鍵進入功能選單。
3. 按  按鍵選擇或調整數值，再按  按鍵完成設定。
4. 按  返回錄影畫面。

6.2 目錄選項

主目錄與目錄選項之詳細說明，請參考下表。

目錄選項	說明	可用選項
播放	選取您要檢視的檔案類別。	錄影 緊急錄影 照片
Wi-Fi	啟用或停用Wi-Fi連線	開 / 關
衛星狀態	顯示目前衛星訊號接收的狀態。	
速度單位	設定系統顯示的速度單位。	KM/H / MPH
測速照相提示	若啟用測速照相提示，當衛星定位完成且車輛接近測速照相機時，設備會發出語音與警示畫面提醒。	開 / 關

目錄選項	說明	可用選項
自訂測速點管理	<p>新增自訂測速點：衛星定位後手動新增自訂的測速照相點，可新增 50 筆測速點至內建系統中。</p> <p>刪除最後一筆：刪除最後一筆自訂測速點。</p> <p>刪除全部測速點：刪除所有自訂測速點。</p>	<p>新增自訂測速點 / 刪除最後一筆 / 刪除全部測速點</p>
自訂限速提示	<p>自訂車速上限，當車速超過設定值設備會發出警示音與警示畫面提醒。</p>	<p>按 \triangle/∇ 按鍵設定車速上限，可自訂為關或 50 ~ 200 km/h (30 ~ 125 mph) 之間</p>
設定時區	<p>設定所在時區。</p>	<p>按 \triangle/∇ 按鍵設定衛星時間，可自訂於 GMT -12:00 ~ GMT +14:00 之間</p>
時間設定	<p>設定日期與時間。</p>	<p>按 \triangle/∇ 按鍵調整數值，再按 \odot 按鍵切換欄位與確認</p>
語言設定	<p>設定系統語言。</p>	<p>依商品實際出貨地區</p>
影像解析度	<p>設定影片的影像解析度。</p>	<p>1920x1080 30fps HDR 1920x1080 27.5fps HDR 1280x720 30fps HDR 1280x720 27.5fps HDR</p>

目錄選項	說明	可用選項
EV	設定曝光補償。	按 Δ/∇ 按鍵設定曝光值，可自訂於 -2 ~ +2 之間
螢幕設定	設定螢幕關閉的時間。在待機或錄影中達設定時間未操作，設備會暫時關閉螢幕，按任意操作按鍵即可開啟螢幕（螢幕關閉時不影響錄影）。	開 / 7秒鐘關閉 / 1分鐘關閉 / 3分鐘關閉
聲音記錄	設定錄影時是否錄音。	開 / 關
音效設定	設定開機音效及按鍵音	開 / 關
音量	設定提示音的音量。	按 Δ/∇ 按鍵設定音量，可自訂於 0 ~ 10 之間
錄影間隔	設備依循您所設定的影片長度將錄製的影片儲存為各個檔案。	30秒 / 1分鐘 / 3分鐘
停車模式	若啟用停車模式其中之一，記錄器在開機狀態下斷開外接電源，10 秒後會自動進入停車模式。* 必須事先安裝ACC常時電源線。	關 / 停車錄影 / 移動與碰撞偵測 / 縮時錄影

目錄選項	說明	可用選項
碰撞偵測	若啟用碰撞偵測，當設備感測到碰撞時，設備會自動啟動緊急錄影。	高靈敏度 / 中靈敏度 / 低靈敏度 / 關
駕駛休息提醒	若啟用駕駛休息提醒，當開機達 一小時設備會發出警示音與警示畫面提醒，並每隔三十分鐘重複警示。	開 / 關
車道偏移偵測	若啟用車道偏移偵測，當衛星定位完成後，行車時速達 70 km/h (43 mph) 以上且偏離行駛車道或變換車道時，設備會發出警示音與警示畫面提醒。	開 / 關
前車車距偵測	若啟用前車車距偵測，當衛星定位完成後，行車時速達 60 km/h (37 mph) 以上且與前方車距低於 20 公尺 時，設備會發出警示音與警示畫面提醒。	開 / 關
檔案刪除	刪除檔案。	錄影 緊急錄影 照片
電源頻率	家用電源規格按地區不同，建議參考各國電壓頻率表作設定。	60Hz / 50Hz

目錄選項	說明	可用選項
格式化	將設備中的記憶卡格式化，所有的檔案都將喪失。	是 / 否
回復原廠設定	將系統回復到出廠的設定。	是 / 否
韌體版本	顯示當前韌體版本。	

7 SuperCar 2.0

請至此連結

https://ftp.digilife.com.tw/SuperCar_2.0/SuperCar_2.0.zip

下載專屬影片/GPS播放器SuperCar 2.0 軟體。



編號	項目
1	播放前鏡頭錄影
2	瀏覽檔案
3	截圖
4	快退
5	播放/暫停

編號	項目
8	播放時長
9	重力值
10	播放後鏡頭錄影
11	軟件版本號
12	地圖

6	快進
7	音量

13	檔案列表
14	更換語言及地圖系統

備註：

- 影片播放前須確認已連接網際網路，行車路徑才能於電子地圖顯示。
- SuperCar 軟體僅適用於 Windows 作業系統的電腦。

8 規格

項目	說明
影像感應器	1/2.8" Sony's Starvis CMOS 感應器
有效像素	1920 (H) x 1080 (V)
儲存媒體	支援 microSD 速度等級 10 以上，且記憶體容量 16GB 以上的 micro SD 卡 (最高支援 128GB)
LCD 顯示器	1.3" TFT LCD 彩色螢幕
鏡頭	廣角固定焦距鏡頭 F1.8
對焦範圍	1.5m ~ 無限
衛星系統	GPS
影像檔	解析度： 1920x1080 30fps HDR 1280x720 30fps HDR 1920x1080 27.5fps HDR

項目	說明
	1280x720 27.5fps HDR 格式：TS
靜態圖像	解析度：依影像解析度設定為主 格式：JPEG
快門	電子快門
重力感應器	3-Axis G-Force 感應器
ISO	自動
白平衡	自動
麥克風	是
喇叭	是
界面	Mini USB, A/V port
電源	超級電容
最佳工作溫度	0° ~ 45° C
操作濕度	20 ~ 70% RH
儲存溫度	-20° ~ 70° C
尺寸	93.8 x 48.9 x 40 公釐
重量	約 76 克 (不含記憶卡)

內建 IEEE 802.11g/n(HT20) Wi-Fi 芯片: RTL8188FTV

Wi-Fi 頻寬	2412~2472MHz
Wi-Fi 頻道列表	Ch1~Ch13
Wi-Fi 最大輸出	18dBm

9 限用物質含有情況說明書

設備名稱：行車記錄器

型號（型式）：f920x

Equipment name: Car Camcorder

Type designation (Type)

限用物質及其化學符號

Restricted substances and its chemical symbols

單元 Unit	限用物質及其化學符號 Restricted substances and its chemical symbols					
	鉛 Lead (Pb)	汞 Mercury (Hg)	鎘 Cadmium (Cd)	六價鉻 Hexavalent chromium (Cr ⁺⁶)	多溴聯苯 Polybrominated biphenyls (PBB)	多溴二苯醚 Polybrominated diphenyl ethers (PBDE)
主機外殼及元件	○	○	○	○	○	○
主機內部電子元件	○	○	○	○	○	○
充電器外殼及元件	○	○	○	○	○	○
充電器內部電子元件	○	○	○	○	○	○

備考1. “超出0.1 wt %”及“超出0.01 wt %”係指限用物質之百分比含量超出百分比含量基準值。

Note 1: “Exceeding 0.1 wt %” and “exceeding 0.01 wt %” indicate that the percentage content of the restricted substance exceeds the reference percentage value of presence condition.

備考2. “○”係指該項限用物質之百分比含量未超出百分比含量基準值。

Note 2: “○” indicates that the percentage content of the restricted substance does not exceed the percentage of reference value of presence.

備考3. “-”係指該項限用物質為排除項目。

Note 3: The “-” indicates that the restricted substance corresponds to the exemption.