



**m500**

**Moto Cam  
User Manual**



**This product is designed with waterproof. However, it is forbidden to use a strong jet of water to rinse or flush the product. The warranty will be invalid if the damage is caused by this reason.**

# Contents

About this Guide .....	3
Regulatory notices.....	3
Prohibition of co-location.....	3
WEEE Notice.....	3
CE Regulatory Notice .....	3
Notes on Installation .....	3
<b>1 Introduction .....</b>	<b>6</b>
1.1 Feature.....	6
1.2 Package Contents .....	6
1.3 Product Overview.....	7
1.3.1 Host.....	7
1.3.2 Easy Pad.....	7
1.4 Getting Started .....	8
1.4.1 Insert the Memory Card .....	8
1.4.2 Remove the Memory Card.....	8
1.5 Installation.....	9
1.5.1 Connect host and accessories .....	9
1.5.2 Installation position.....	10
1.5.3 Install power cable.....	11
1.5.4 Install front cam on rear-view-mirror .....	11
1.5.5 Adjust view angle, calibrate and format .....	14
<b>2 Setting.....</b>	<b>15</b>
2.1 Download Go Moto Plus app .....	15
2.2 Wi-Fi Connection.....	15
2.3 Use Go Moto Plus app .....	16
<b>3 SuperCar 2.0.....</b>	<b>25</b>
<b>4 Specification.....</b>	<b>26</b>

## About this Guide

The content in this document is for information purpose and is subject to change without prior notice. We have made every effort to ensure that this User Guide is accurate and complete.

However, no liability is assumed for any errors or omissions that may have occurred.

The manufacturer reserves the right to change the technical specifications or accessories without prior notice.

## Regulatory notices

This document provides country- and region-specific non-wireless and wireless regulatory notices and compliance information for your product. Some of these notices may not apply to your product.

### Prohibition of co-location

This device and its antenna(s) must not be co-located or operated in conjunction with any other antenna or transmitter.

### WEEE Notice

#### Disposal of Waste Electrical and Electronic Equipment and/or Battery by users in private households in the European Union



Battery

This symbol on the product or on the packaging indicates that this cannot be disposed of as a household waste. You must dispose of your waste equipment and/or battery by handling it over to the applicable take-back scheme for the recycling of electrical and electronic equipment and/or battery. For more information about recycling of this equipment and/or battery, please contact your city office, the shop where you purchased the equipment or your household waste disposal service. The recycling of materials will help to conserve natural resources and ensure that it is recycled in a manner that protects human health and environment.

## CE Regulatory Notice

The product herewith complies with the requirements of IEC 62368-1:2014, the EMC Directive 2014/30/EU, the RED-Directive 2014/53/EU and the RoHS Directive 2011/65/EU.

EU Health Protection: This equipment should be installed and operated with minimum distance 20cm between the radiator & your body.

## Notes on Installation

1. Keep the wire and host mounted away from the high-voltage ignition coil.
2. Do not bend the wires and connectors severely while installation.
3. Do not touch the lens with your fingers. Finger grease may be left on the lens and will result in unclear videos or pictures. Clean the lens on a regular basis.

4. Use the attached power cable and wires for installation only. Please do not use other brand of power cable or wires to avoid equipment burn or explosion.
5. Please seek for professional shops and technicians for installation.

## **Caution**

- ❖ Due to local laws and vehicles safety considerations, do not operate the camcorder while driving.
- ❖ Set up time zone, time and date accurately before you use this camcorder.
- ❖ Please use SuperCar software under the condition that Electronic Map are functioning normally.
- ❖ The firmware function in the camcorder is for reference only, drivers are advised to exercise discretion based on actual road conditions.
- ❖ The results of GPS positioning are only for reference, and should not affect the actual driving situation. The camcorder also cannot ensure the positioning accuracy.
- ❖ GPS positioning accuracy may differ depending on weather and location such as high buildings, tunnels, undergrounds, or forests. GPS satellite signals cannot pass through solid materials (except glass). Tinted window will also affect the performance of the GPS satellite reception.
- ❖ GPS reception performance on each camcorder may differ. The camcorder cannot determine the accuracy of the positioning results from different hardware.
- ❖ The values displayed in this camcorder, such as speed and position, may be inaccurate due to the influence of surrounding environment. They are for your reference only.
- ❖ This product is used only for non-commercial use, within the maximum limits permitted by applicable law. We do not take any responsibilities for the loss of use of the product.
- ❖ This camcorder gets warm when in use; this is normal.
- ❖ Improper use or operation of the product may result in damage of the product or its accessories and void the warranty.
- ❖ Wi-Fi Signals are unable to pass through the building. The limit of signal transmission is 5m.
- ❖ Wi-Fi Operation Channel: Ch1~Ch13
- ❖ The product employs wireless data communication which may interfere, or be interfered by, a near-by camcorder.
- ❖ Never use this camcorder in the vicinity of a microwave oven or at places where there is radio interference.
- ❖ Radio wave reception may be worsened in specific environments.
- ❖ Please be advised that if another camcorder is also using the same 2.4GHz band as this product, the processing speed of both camcorders may slow down.
- ❖ This product gets warm when in use; this is normal.
- ❖ Improper use or operation of the product may result in damage of the product or its accessories and void the warranty.
- ❖ The radio frequency (RF) generated by this RF electronic camcorder may cause adverse effects on the operation of other electronic camcorders and

result in malfunctioning. Wireless transmitters and circuitry may also interfere with other electronic camcorders. Therefore, do observe the following precautions:

- **Aircraft:** Never use a radio transmitter when you are in an airplane. Please switch off the Wi-Fi function of the camcorder.
  - **Vehicle:** The radio frequency transmitted by this camcorder may affect the electronic system in a motorized vehicle. Please consult the manufacturer or dealer of your vehicle on the possible effect.
  - **Pacemaker:** In order to prevent any potential interference to a pacemaker, anyone who uses a pacemaker should be advised, that, when using this camcorder, a minimum distance of 15cm (6 inch) should be kept between the camcorder and the pacemaker; and never put this camcorder in a chest pocket. In case of any doubt of interference, switch off the camcorder immediately.
  - **Medical Camcorder:** If you use a personal medical camcorder, consult the camcorder manufacturer or your physician to confirm if your camcorder is sufficiently shielded from the RF transmission of this camcorder.
  - **Medical Facilities:** Hospitals and medical institutes may use facilities that are sensitive to an external RF energy. Observe such instructions when the medical care personnel or any posted sign requests you to switch off any camcorder that may interfere the radio frequency.
  - **Explosion sites or any location with a posted sign:** In order to prevent interfering with an explosion activity, observe all the signage and instructions in the Explosion Area or in a zone with a “Switch Off 2-way Radios” sign by switching off camcorders that may interfere with the radio frequency.
- ❖ HP Inc. is NOT responsible for the loss of any data/content during operation.
- ❖ **Product application disclaimer**  
Please scan the QR code below and read the product application disclaimer carefully.



**When you start using the system, it is assumed that you agree to the above statement.**

# 1 Introduction







Thank you for purchasing this advanced Moto Cam. This product is specifically designed for real time video recording when riding scooter.

## 1.1 Feature

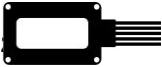
- Intelligent Noise Reduce, suppress surrounding noise efficiently
- Dual waterproof camera, super high resolution
- 2MP sensor
- Wi-Fi and friendly app
- Host and accessories all waterproof
- Hot key to lock the file
- Freely position GPS in any better reception(GPS is optional)
- Collision and topple-over detection, auto emergency recording

## 1.2 Package Contents

The package contains the following items. In case there is any missing or damaged item, contact your dealer immediately.

Host	Front/rear camera	GPS(optional)
		
Easy Pad	Power cable	Installation Kit
		

## 1.3 Product Overview

### 1.3.1 Host

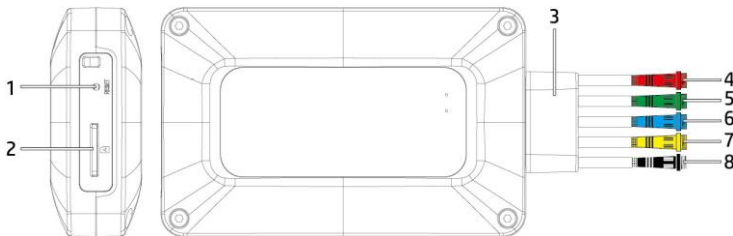

編號	名稱	編號	名稱
1	Reset	5	Green: to connect GPS(optional)
2	microSD slot	6	Blue: to connect rear camera
3	5in1 connector	7	Yellow: to connect Easy Pad
4	Red: to connect power cable	8	Black: to connect front camera

### 1.3.2 Easy Pad

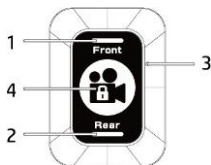

No	Item	Function
1	LED indicator - front camera	-LED always on: power on (standby) -LED flash: front camera is in recording -LED flash quickly: speed cam alert. *Note
2	LED indicator - rear camera	-LED always on: power on (standby) -LED flash: rear camera is in recording
3	Microphone	For Intelligent Noise Reduce
4	Lock file / Wi-Fi	-short press: to lock the file -long press: turn on Wi-Fi



**Note:**

1. The speed cam alert function must have the speed cam map datum of the country or region built into the GPS of the device. If there is no built-in map datum, this function will not work. If GPS is not installed, this function has no effect either. The speed cam alert function is for reference only, and it's not guaranteed to cover all speed cam spots on the driving route. Please make own judgments based on actual road conditions while driving.
2. The speed cam map datum depending on shipping area. Please contact distributor whether if it's built-in or not for your area.

## 1.4 Getting Started

### 1.4.1 Insert the Memory Card

Insert memory card with the gold pins facing forward, and the nameplate of the host is toward up, see the picture as below,

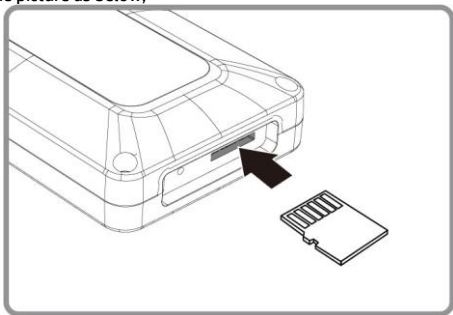

### 1.4.2 Remove the Memory Card

Turn off the scooter's engine, and the camera will power off accordingly. Once the camera is completely powered off, you can remove the memory card from memory slot.

**Note:**

1. Don't remove or insert the memory card while the camera is in working status. This may damage the memory card or cause data lose.
2. Support microSD card speed V30 or higher and capacity 16GB or greater. (support up to 128GB)
3. Please use Go Moto Plus app to format the memory card and sync the date and time before the initial use.
4. Please regularly format memory card and sync date/time. (Recommend once a month)

## 1.5 Installation

Below installation is for reference only. Please contact professional shops and technician for installation.

### 1.5.1 Connect host and accessories

Connect host with power cable, front camera, rear camera, GPS and easy pad according to connector's colors.

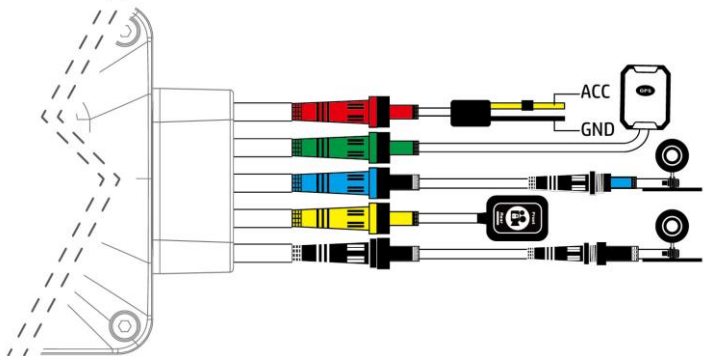

## 1.5.2 Installation position

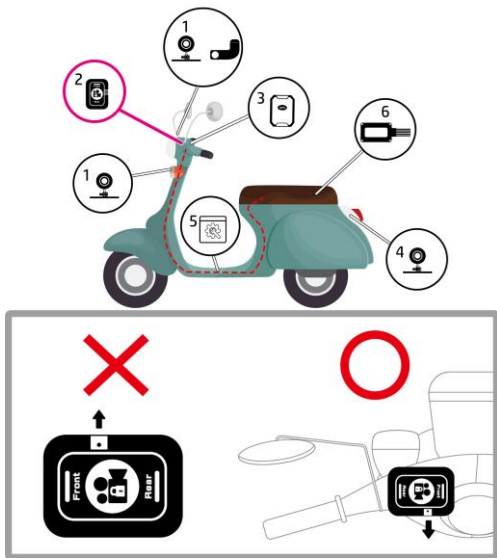

No	Item	Installation position
1	Front camera	To be fixed on scooter's head or the central of front case. Or use rear-view-mirror mount and fix it on the scooter's rear-view-mirror.
2	Easy pad	To be fixed on the front handle. (refer to above drawing) DO NOT put the Microphone toward to front end.
3	GPS(optional)	To be fixed on a good reception of front handle..
4	Rear camera	To be fixed on the car plate or rear handle.
5	Installation	Use Installation Kit to mount the host, accessories and wires. Refer to above image and the wiring route to install all items.
6	Host and wires	Put and fix the host and accessories' wires in the cabinet. Use Velcro to fix the host on the inner side of cabinet; it's Convenient to remove the host and take out memory card to check. *When installation is completed, use Go Moto Plus app to calibrate topple-over detection. (Tilt Detection).

### 1.5.3 Install power cable

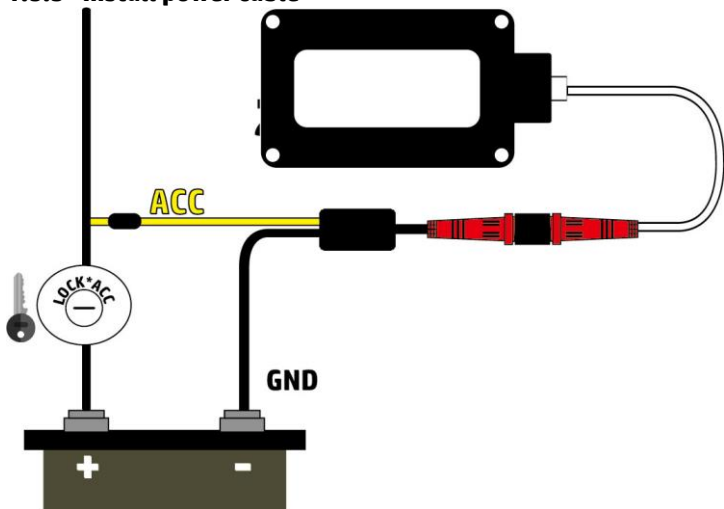

### 1.5.4 Install front cam on rear-view-mirror



1. Disassemble the original mount from the camera.



2. Temporarily take out the metal ring and put the Anti-slippery Sticker on the gutter of the camera. Then, peel off the transparent film. Put on metal ring once again.



3. Insert **A** of the Mount in the middle of metal ring, and confirm the white mark on camera is always positioned up. This is to make sure the capture image is in correct angle. Use screw driver to fix to the Mount.



4. Take out the rear-view-mirror from the motorcycle. Insert **B** of the Mount into the bar of rear-view-mirror.



5. Put the whole set of rear-view-mirror back to motorcycle and fix it steadily.



It's highly recommended to install the Rear-view-mirror Mount on the right side of the motorcycle. If install on the left side, refer to below image for installation rendering.



## 1.5.5 Adjust view angle, calibrate and format

Use Go Moto Plus app to adjust the view angle.

After adjusting your viewing angle, tap  in the Go Moto Plus app to enter “Camera Setting” . On first use, be sure to calibrate “Tilt Sensor” and “Format” microSD card.

### Calibrate the Tilt Sensor:

Hold your motorcycle upright, straight and still as possible, then tap on “Tilt Sensor” in the menu so the Main Unit can calibrate the internal tilt sensor. After the calibration is completed, if the camera detects that the motorcycle is toppled over, it will trigger emergency recording automatically. This is indicated by the blue LED going from a slow flash to a rapid flash. Emergency recordings are stored in the emergency video folder. When the Folder is full, app will pop-up message of “Emergency video files will be overwritten by loop recording. Backup important files.” . Regularly check the recorded files and backup if needed.

\*The auto detection of emergency recording can be turned on or off from Camera Setting.

### Format microSD card:

Tap “Format” in the menu to format microSD card. It is recommended to format your card at least once a month to ensure that it is working properly. Make sure backup important files before formatting.

## 2 Setting

### 2.1 Download Go Moto Plus app

The Moto Cam allows you to connect to the smart phone to preview, set-up camera, synchronize date/time and calibrate topple-over detection. When using the Moto Cam for the first time, download and install [Go Moto Plus] app from your smart phone.



1. Download **Go Moto Plus** application from Google Play Store or Apple App Store.
2. Complete the installation.

APP layout and features may be changed subject to different software versions. Please refer to Google Play or APP Store for update.

### 2.2 Wi-Fi Connection

1. Press the button on Easy Pad for 3 seconds to turn on Wi-Fi.
2. Using the Wi-Fi function of your smart phone, search for the Moto Cam ID "hp\_m500\_123456" from the list (last 6 numbers are system random numbers). Enter default password **12345678** to connect with Moto Cam.
3. Use downloaded app Go Moto Plus to start setting or operating other functions.

**Note:**

1. Wi-Fi is default ON for 3 minutes when power on. If there is no connection with app within 3 minutes, Wi-Fi will be turned off automatically. To turn on again Wi-Fi, long press Easy Pad button for 3 seconds.
2. The smart phone shall be within a maximum of a 5m distance from the host without any buildings in between.
3. The language of the [Go Moto Plus] app will be consistent with your smart phone, beyond the language options, the App will be activated with default language.



## 2.3 Use Go Moto Plus app





Tap [Go Moto Plus]  icon to activate the application. The main screen will pop up. Follow the below instruction to operate this application.



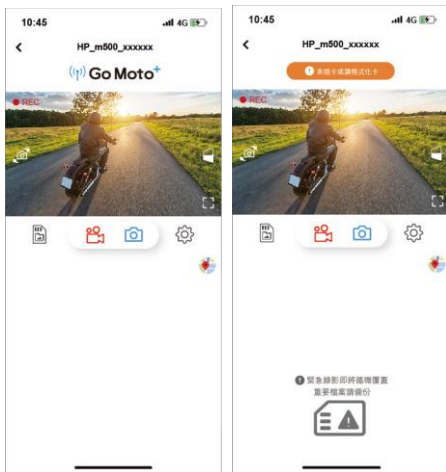

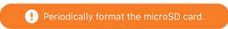



## 2.3.1 Camera preview, record, snapshot

You can use this feature to preview, record or take snapshot.



icon	Description
 / 	Go Moto Plus logo / memory card message
	Preview
	Switch front and rear camcorder preview
	180 ° Rotate the preview angle

	Full screen display
	Start/Stop Record
	Snapshot
	Camera File. Recorded files in microSD card.
	Camera Setting
<p data-bbox="70 546 352 596">Emergency video files will be overwritten by loop recording Backup important files</p> 	<p data-bbox="393 546 947 659"><b>Note:</b> The emergency videos folder in microSD reaches capacity, and will be overwritten by new recordings. Please back up important files. This message icon will eliminate after backup.</p>
	Map and riding track

**Note:**

1. The App will auto sync the camera's date/time with your smartphone.
2. App layout and features are subject to change, depending on the software version. Refer to the Google Play Store or iOS App Store for the latest updates.
3. Android phones please download Google Offline Maps first. First, update Google Maps to the latest version, open the Google Maps app, click on the user account picture above, and click "Offline Area", select "Custom Area", select the area where you want to download the offline map, confirm and press "Download".

## 2.3.2 Playback, delete, download

You can use this feature to playback or delete the file saved in camcorder, or to download the file from camcorder to your mobile device.



1. Touch the icon  [Camera File].

2. The files saved in the camcorder will be displayed on your smart phone. Camcorder will stop recording for a few seconds until your smart phone finishes reading the saved files from camcorder. There are three folders, Loop, Snapshot and Locked. The “F” and “R” letter at the right bottom corner of preview thumbnail stands for “Front camera” and “Rear camera”. Tap the preview thumbnail to playback the file.



3. Tap the right top corner “Select” and pick up the files that you want to delete or download and tap below icon to execute.



Icon	Description
	Download the file to smartphone.
	Delete file from microSD card.
	Downloaded file will mark as “Downloaded” on preview thumbnail. It can be opened from “Album” without Wi-Fi connection to the camera.

**Note:**

1. If recordings have no audio, check if Microphone is OFF in the menu. For video playback, we recommend VLC Media Player.
2. Deleted files cannot be recovered. Backup any important files before deleting them.
3. The snapshot is activated by app. The image file will be stored both in microSD card in the camera and “Album” folder of MUFU Video app. The file will be marked as “Downloaded” on preview thumbnail.
4. If you plan to download a large number of videos and photos, take out the microSD card and use PC/Mac.

## 2.3.3 Local Album



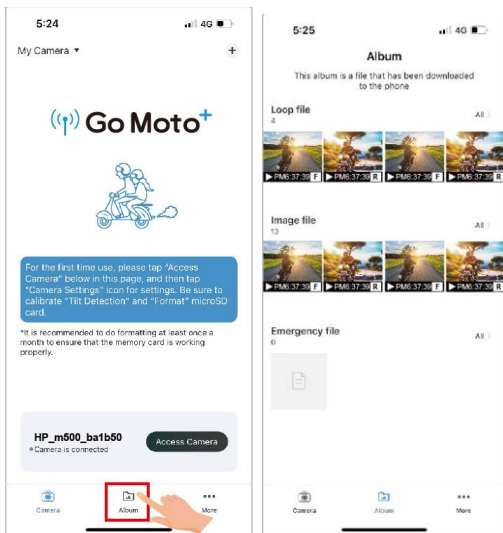

You can use this feature to playback or delete the file that you download in your smart phone. The file can be opened and reviewed without Wi-Fi connection to the camera.

1. Tap the icon  [Album] below the home page. The camera will stop recording if it's connected with app.

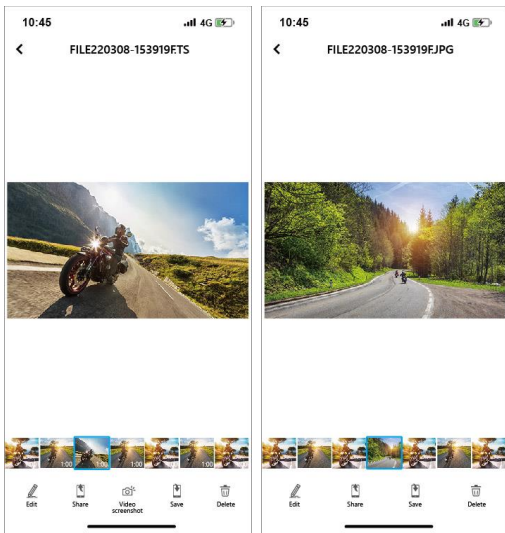

Tap the file from preview thumbnail to playback, delete or edit.



Icon	Description
	Edit the video or photo. (refer to next step for details.)
	Share the video or photo to social media.
	Video screenshot.
	Save the video or photo to smartphone's album. When the file is saved, the screen will show a message of "Save to smartphone's album successfully." and smartphone's album will automatically create a folder named "Go Moto Plus" .
	Delete the file downloaded in App's Album. The file in the microSD card in the camera is still existed.

## 2.3.4 Camera Setting

You can use this feature to set up your car camcorder.



1. Tap icon [Camera Setting].
2. Refer to the below table for details of menu items and available menu options.

Menu Option	Description	Available options
*Set Time Zone	To set up time zone in order to auto sync date/time once GPS is positioned. *Optional GPS needs to be installed to activate this function.	GMT -12 ~ GMT +12
*Speed Cam Alert	When this function is enabled and GPS is positioned, once your scooter is approaching speed cam, the LED on Easy Pad will flash quickly. *Optional GPS needs to be installed to activate this function. *If there is no speed cam map datum built-in, the LED will not flash quickly.	On / Off
Voice Record	Setting voice record in the video.	On / Off
Record Interval	Save respective video files in a length of the selected duration.	1 min / 3 min / 5 min
Intelligent Noise Reduce	If turn on this feature, it can suppress surrounding noises and deliver human voice more clear.	On / Off
Tilt Sensor	When the host is installed completely, please use this function to calibrate topple-over detection.	OK / Cancel
Emergency Recording	Enable/Disable emergency recording function. *The emergency recording folder is occupied 20% of memory card. Even it turns off, this capacity is still occupied. *Set up "Off" will turn off auto emergency, but the user still can hit the Easy Pad button to activate emergency recording manually.	On / Off
Format	To format the memory card, all the files in the camcorder will be deleted.	Yes / Cancel
*Speed Unit	Set up speed unit. *Optional GPS needs to be installed to activate this function.	Km/h, mph
*Car Speed Watermark	To turn on or off car speed watermark. *Optional GPS needs to be installed to activate this function.	On / Off



Anti-flicker	Domestic power supply varies by area. It is recommended that you should check the "Table of voltage and frequency of different countries" for the correct setting.	50Hz / 60Hz
Wi-Fi Setting	To set up Wi-Fi password	
Default	Return to factory default setting.	Yes / Cancel
Firmware Version	Indicates the current camcorder's firmware version.	

### 3 SuperCar 2.0

Please click this link to download particular video/GPS player SuperCar 2.0:  
[https://ftp.digilife.com.tw/SuperCar\\_2.0/SuperCar\\_2.0.zip](https://ftp.digilife.com.tw/SuperCar_2.0/SuperCar_2.0.zip).



No.	Item
1	Front Camera Playback
2	Browse File
3	Capture
4	Fast Backward
5	Playback / Pause
6	Fast Forward
7	Volume
8	Playback Duration

No.	Item
9	G-sensor Value
10	Rear Camera Playback
11	Software Version
12	*Map(riding route)
13	File List
14	Language and Map Change

Note:  
 1. To display the route on Electronic Map, please make sure the internet is connected before starting the video playback.  
 2. The SuperCar 2.0 software is only applicable to Windows operating system.

## 4 Specification

Item	Description
Image sensor	1/2.9" 2MP CMOS sensor
Effective pixels	1920 (H) x 1080 (V)
Storage media	Supports microSD 16GB above and class V30 speed or greater, up to 128GB
Lens	Wide Angle Fixed Focus lens Aperture: F/1.55
Focus range	1.5m~Infinity
Satellite System	GPS (External/optional)
Video file	Front camera: 1080p/30fps Rear camera: 1080p/25fps
	Format: TS
Still image (Photograph)	Use app to take photo
	Format: DCF (JPG)
G-Sensor	3-Axis G-Force sensor
ISO	Auto
White Balance	Auto
Microphone	Built-in
Speaker	N/A
Power	Super Capacitor
Operating Temperature	-10° ~ 60° C
Operating Humidity	20 ~ 70% RH
Storage Temperature	-20° ~ 70° C
Host Dimensions	80 x 50 x 20 mm
Host Weight	Approx. 84g

Built-in IEEE 802.11g/n(HT20) Wi-Fi chip: RTL8188FTV

Frequency range	2412~2484MHz
Wi-Fi Channel	Ch1~Ch13
Wi-Fi Max. output	18dBm