



MUFU

More Unique For You

V11S
Moto Cam
User Manual

Thank you for purchase MUFU moto cam. This product is specifically designed to record real time video when riding a scooter or motorcycle. The content in this document is for informational purpose only and is subject to change without prior notice. We have made every effort to ensure that this User Manual is accurate and complete, however, no liability is assumed for any errors or omissions.

The manufacturer reserves the right to change the technical specifications or accessories without prior notice.

Please visit official website for the latest version of user manual.

Notice

- ❖ Please peel off the protective film from the camera lens before use.
- ❖ Do not touch the lens with your fingers. Finger grease may be left on the lens, resulting in unclear videos or pictures. Inspect and clean the lens with a soft, non-abrasive cloth regularly.
- ❖ Please charge the unit to full before first use using the provided USB Type-C cable. Please do not use another brand of charging cable to avoid a potential equipment malfunction. The red LED on the camera will illuminate when charging, and green LED will illuminate when reaching full charge.
*Charging adapter can use 5V, 1A and higher, USB Type-A port.
- ❖ If the unit will not be used for an extended period of time, please charge at least once every 6 months to maintain the battery's health and avoid low-voltage related damage.
- ❖ Please download MUFU Video app from iOS app store or Google Play Store before use. The Wi-Fi password is **12345678**.
- ❖ By default, Wi-Fi is ON for 3 minutes when the camera is powered on. If it doesn't connect to the MUFU Video app within 3 minutes, the camera will disable Wi-Fi automatically to save

power. To turn on again Wi-Fi, simply power the camera OFF then ON again.

NOTE: An active Wi-Fi connection will affect total recording time.

- ❖ When the main unit connects USB cable for charging, the main unit will power on automatically and turn on Wi-Fi. It's workable to connect app for setting camera or checking recorded files. Idle for 3 minutes, the main unit will power off automatically. Unplug and plug the USB cable once again to re-start the main unit.
- ❖ Recommend to use microSD card V30 or higher and capacity 16GB or higher (up to 128GB).
- ❖ Format microSD card regularly and synchronize date/time. (Recommended: Once per month.)
- ❖ **In a high humidity environment or when travelling between areas with a large temperature difference, light moisture or fog may appear on the lens. This is normal. If this happens, remove the microSD card, and remain the microSD card slot cover opening, let the microSD card slot faces up for several hours until the internal moisture or fog evaporates, and then reinsert the card and resume use.**
- ❖ The friction scratches caused by the regular buckle of the main unit mount are normal and do not affect the use. Due to the production test, the main unit mount will have some micro-friction scratches. This is normal.
- ❖ To avoid the product damage or accidents from product dropping, install the product properly and solid before take a ride.
- ❖ Due to the various specifications of memory cards on the market, and the quality is uneven, we do not guarantee that all memory cards are compatible with our products. If there is a memory card abnormality, resulting in the inability to store recorded images, It's not directly related with the dashcam. Please swap the new card from where you purchased.

- ❖ The warranty doesn't cover damages resulting from alteration, adjustment or repair by unauthorized person.

Prohibition of co-location

This device and its antenna(s) must not be co-located or operated in conjunction with any other antenna or transmitter.

WEEE Notice

Disposal of Waste Electrical and Electronic Equipment and/or Battery by users in private households in the European Union



WEEE



Battery

This symbol on the product or on the packaging indicates that this cannot be disposed of as a household waste. You must dispose of your waste equipment and/or battery by handling it over to the applicable take-back scheme for the recycling of electrical and electronic equipment and/or battery. For more information about recycling of this equipment and/or battery, please contact your city office, the shop where you purchased

the equipment or your household waste disposal service. The recycling of materials will help to conserve natural resources and ensure that it is recycled in a manner that protects human health and environment.

CE Regulatory Notice

The product herewith complies with the requirements of the EMC and RED Directive 2014/53/EU and the RoHS Directive 2011/65/EU.

EU Health Protection: This equipment should be installed and operated with minimum distance 20cm between the radiator & your body.

Regulatory & Safety Notice

- ❖ This document provides country- and region-specific non-wireless and wireless regulatory notices and compliance information for your product. Some of these notices may not apply to your product.
- ❖ Disposal of a battery into fire or a hot oven, or mechanically crushing or cutting of a battery, that can result in an explosion.
- ❖ Leaving a battery in an extremely high temperature surrounding environment that can result in an explosion or the leakage of flammable liquid or gas.
- ❖ Due to local laws and for your own safety, DO NOT operate the camera while riding.
- ❖ Use MUFU Video to app to synchronize your date and time before first use.
- ❖ The firmware function in the camera is for reference only, riders are advised to exercise discretion based on actual road conditions.
- ❖ This product is intended only for non-commercial use, within the maximum limits permitted by law. We take no responsibility for any losses as a result of use of this product.
- ❖ Wi-Fi Signals are unable to pass through the building. The max limit of signal transmission is 5 meter.
- ❖ Wi-Fi Operation Channel: Ch1~Ch11
- ❖ The product employs wireless data communication which may interfere, or be interfered by, a near-by camera.
- ❖ Never use this camera in the vicinity of a microwave oven or at places where there is radio interference.
- ❖ Radio wave reception may be worsened in specific environments.
- ❖ Please be advised that if another camera is also using the same 2.4GHz band as this product, the processing speed of both cameras may slow down.
- ❖ The camera may get warm during use. This is normal.

- ❖ Improper use or operation of the product may result in damage to the camera or its accessories and void the warranty.
- ❖ This device and its antenna(s) must not be co-located or operated in conjunction with any other antenna or transmitter.
- ❖ The radio frequency (RF) generated by this RF electronic camcorder may cause adverse effects on the operation of other electronic camcorders and result in malfunctioning. Wireless transmitters and circuitry may also interfere with other electronic camcorders. Therefore, do observe the following precautions:
 - Aircraft: Never use a radio transmitter when you are in an airplane. Please switch off the Wi-Fi function of the camcorder.
 - Vehicle: The radio frequency transmitted by this camcorder may affect the electronic system in a motorized vehicle. Please consult the manufacturer or dealer of your vehicle on the possible effect.
 - Pacemaker: In order to prevent any potential interference to a pacemaker, anyone who uses a pacemaker should be advised, that, when using this camcorder, a minimum distance of 15cm (6 inch) should be kept between the camcorder and the pacemaker; and never put this camcorder in a chest pocket. In case of any doubt of interference, switch off the camcorder immediately.
 - Medical Camcorder: If you use a personal medical camcorder, consult the camcorder manufacturer or your physician to confirm if your camcorder is sufficiently shielded from the RF transmission of this camcorder.
 - Medical Facilities: Hospitals and medical institutes may use facilities that are sensitive to an external RF energy. Observe such instructions when the medical care personnel or any posted sign requests you to switch off any camcorder that may interfere the radio frequency.
 - Explosion sites or any location with a posted sign: In order to prevent interfering with an explosion activity, observe all





the signage and instructions in the Explosion Area or in a zone with a “Switch Off 2-way Radios” sign by switching off camcorders that may interfere with the radio frequency.

- ❖ MUFU is NOT responsible for the loss of any data/content during operation.

By using the product, it is assumed that you agree to all of the above statements.

1. What's Inside

The package contains the following items. If any items are missing or damaged, please contact the original place of purchase immediately.

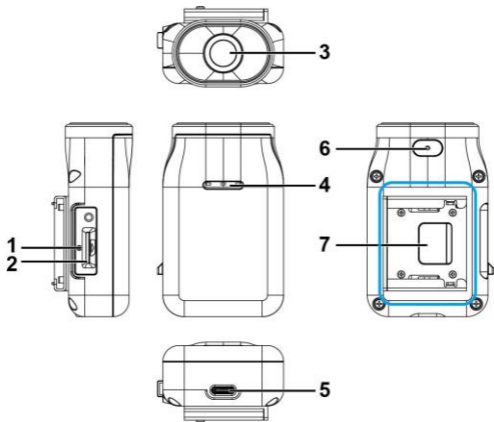

| Camera (Main Unit) | Main Unit Mount | USB Cable (type C) |
|---|---|---|
|  |  |  |
| User Manual | Warranty | |
|  |  | |

2. Product Overview



| No | Description | No | Description |
|----|---------------|----|-----------------|
| 1 | Reset | 5 | USB type C port |
| 2 | microSD slot | 6 | Microphone |
| 3 | Lens | 7 | Bracket |
| 4 | LED Indicator | | |

3. LED Indicator

| Indicator | LED Status | Description |
|--|-----------------------|--|
|  Recording | Blue, slow flashing | Recording |
| | Blue, solid | Camera power on, not recording |
| | Blue, rapid flashing | Emergency recording |
|  Charging | Red, solid | Charging |
| | No Red light | Fully charged |
|  Battery | Green, rapid flashing | Low battery |
| | Green, solid | Full charged |
| USB mode | Red, solid | Connect computer to read memory card (w/o main unit mount) |

Note: Before first use, use the supplied USB type-C charging cable to fully charge the camera.

4. Beep Sound

| Main Unit | Description |
|---|--|
| Beep~ (continuous 5 seconds) Repeat every 30 seconds Total alert 3 times | No card or card error |
| Beep 3 sounds | Power on and start recording |
| Beep~ (continuous 3 seconds) and beep 3 sounds total alert 2 times | Low battery (about 10 minutes to power off) |
| Beep 2 sounds | Power off because of low battery or main unit is apart from main unit mount. |

5. Insert microSD Card

Insert the microSD memory card with the pins facing forward. (See below for proper installation orientation.) Once the memory card locks into place, replace the slot cover securely over the slot.



The slot cover must be tightly sealed to prevent moisture from entering, causing the lens to fog. Insert the left edge of the slot cover, and then press the right edge of the slot cover to create a good seal. See below.



6. Download the App

When using the camera for the first time, use your smartphone to download and install the **MUFU Video** app. Scan the QR code or search “MUFU Video” in the iOS App Store or Google Play Store.



iOS



Android

App layout and features may be changed subject to different software versions. Please refer to the Google Play Store or iOS App Store for the latest version.

7. Power On and Off

Following is the way to power on/off the camera.

1 Buckle Detection

Buckle the camera into the main unit mount, the camera will automatically power on and start recording. Remove the camera from the main unit mount, the camera will power off automatically.

2 Vibration Detection

When pick up the helmet with camera and the main mount buckled, the camera will automatically power on and start recording. If the helmet idles for 3 minutes, the camera will power off automatically. This is for the rider's convenience to store the helmet in the cabinet without taking out camera. *This function is activated on the premise that the camera is buckled with the main unit mount, and "Vibration Detection to turn on/off the device" on app's [Camera Setting] is turned on.

3 Charging

When the camera is charging, the camera will power on and Wi-Fi will be turned on, too. Connect app for camera setting or files review. Camera will power off if app is not connected and used in 3 minutes.

**Main unit is apart from main unit mount.

**Main unit won't record when charging.

Note:

1. When the camera is buckled into the main unit mount, it will automatically power on and start recording, indicated by a slow-flashing Blue LED light. The recording file will be saved onto the microSD card. When the card reaches capacity, the loop recording function will overwrite the oldest file to make room for new files and continue recording.
2. If the Blue LED is not flashing, check if the memory card is inserted. If the card is existed, try to format the card or change a new card.

8. Wi-Fi Connection

When the camera's Wi-Fi is turned on, using your smartphone, search nearby Wi-Fi networks for MUFU_V11S_XXXXXX and tap to connect. Enter password **12345678** to connect to and control the camera. Followings are ways of turning on Wi-Fi.

① When secured into the main unit mount, the camera and its Wi-Fi will automatically power on. If the camera doesn't connect with the MUFU Video app within 3 minutes, Wi-Fi will be disabled automatically to preserve battery life. If you want to turn on Wi-Fi once again, simply remove the camera from the mount, wait for all indicator lights to turn off, and buckle it in once again to power on the camera and reactivate the Wi-Fi.

② When the camera takes out main unit mount and charges with USB-C cable, it will turn on Wi-Fi and enable to use app. The camera will not record in charging mode. The camera will power off if the app is not in use for 3 minutes.

Note:

1. Your smartphone must be within a maximum 5-meter distance from the camera with no buildings in between.
2. The language of the app will be consistent with your smartphone. Beyond the language options, the app will be activated with the default language.
3. Once the camera is connected with computer, it will enter USB mode. It's able to read and download the files from the camera. In this mode, camera won't turn on Wi-Fi.

9. Install & Uninstall

9.1 Install

① Buckle the camera into main unit mount. Blue indicator lights up.



② Put ① buckled camera and mount on the top of helmet. Temporarily fix it in order to adjust the best view angle.



3 Make sure your phone is connected with MUFU_V11S_xxxxxx via Wi-Fi, and open the MUFU Video app to check preview image. Move right or left, forward or backward the mount to obtain the best recording image angle.

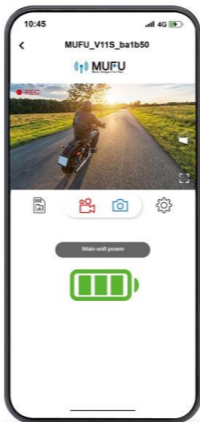

4 After the recording angle is confirmed, pull down the camera and the main unit mount from helmet. And take the camera and main unit mount apart.

5 Wipe the newly confirmed helmet sticking area, and after its surface dries, peel off the protective plastic sheet from the adhesive pad on the main unit mount, stick and press the main unit mount to the helmet. Wait for 12 hours for firmly

fixing. And then buckle the camera on the main unit mount and start using.



9.2 Uninstall

Press the lock on right side of the main unit mount, push the camera to left side to remove it.



10. Calibrate and Format

After adjusting your viewing angle, tap  in the MUFU Video app to enter [Camera Setting]. On first use, be sure to calibrate the “Tilt Sensor” and “Format” the microSD card.

1 Calibrate the Tilt Sensor

Hold your motorcycle upright, straight, and as still as possible. The camera buckles on the main unit mount at the helmet. Put the helmet on your head and sit down on the motorcycle. Then, tap on “**Tilt Sensor**” in the menu so the camera can calibrate the internal tilt sensor. After calibration is completed, if the camera detects that the motorcycle is toppled over, it will trigger emergency recording automatically. This is indicated by the blue LED going from a slow flash to a rapid flash. Emergency recordings are stored in the emergency video folder. When the folder reaches capacity, app will remind with “Emergency video files will be overwritten by loop recording. Backup important files.” Please check and backup emergency files regularly.

2 Format microSD card



Tap “Format” in the menu to format microSD card. It is recommended to format your card at least once a month to ensure that it is working properly. Backup important files before format SD card.

Note:

1. DO NOT remove or insert memory card when the camera is in power-on status. This may cause memory card damage or data loss.
2. Memory cards have a service life. Long-term use may lead to write speed degradation and file save failure. If this happens, it is recommended that you purchase a new memory card.
3. "Emergency Record" can be disabled from app. The emergency folder is occupied 20% capacity of memory card. Even this function is disabled, the space is still reserved.

11. Change Password

To change the Wi-Fi password, follow the steps below. If leave it unchanged, the default password is **12345678**.

- 1 Open MUFU Video app , and tap  to enter [Camera Setting], Next, tap [Wi-Fi Password Setting].

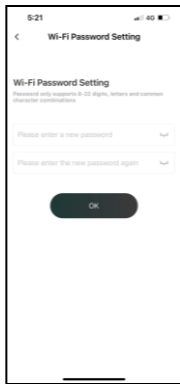

- Enter your new password.
- Enter your new password again to confirm.
- Tap “OK”, and screen will show message of “The camera needs to be reconnected after completion, please confirm the change?”. Tap “OK”.
- It will automatically lead to previous page. The screen will

show “Please ignore the network named MUFU_V11S_XXXXXX in the [Settings-Wi-Fi] option of the iPhone, and then enter the new password to rejoin.”

→ Close app, and follow by step ② to re-connect Wi-Fi.

② iPhone users: Open the Wi-Fi connection menu and tap the icon ⓘ by side of MUFU_V11S_XXXXXX network. Next, tap “Forget This Network” and confirm your decision.

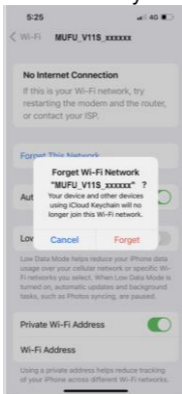

***Note:** Android phone user can skip this step.







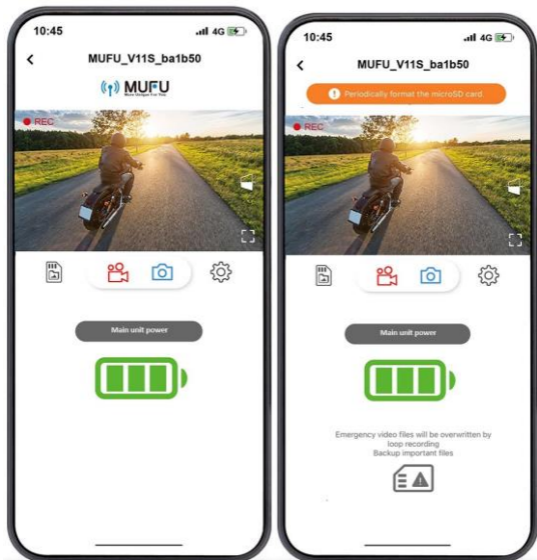

③ Next, tap the V11S network again to re-enter your new password and reconnect your smartphone to the MUFU Video.



Note: Be sure to remember your new password. If you forget your new password, a factory reset will be necessary.

12. App Operation

1 Main Screen



| 圖示 | 敘述 |
|---|--|
|  | MUFU logo / microSD card message |
|  | Preview image |
|  | Switch front and rear preview image |
|  | Rotate 180° preview image |
|  | Full screen preview |
|  | Start / Stop recording |
|  | Take snapshot |
|  | Camera Files (review recorded files in V11S's microSD) |
|  | Camera Setting |

| | |
|---|---|
| <p>Main unit power</p>  | <p>Note: the remaining battery</p> |
| <p>Emergency video files will be overwritten by loop recording Backup important files</p>  | <p>Note: The emergency videos folder in microSD reaches capacity, and will be overwritten by new recordings. Please back up important files. This message icon will eliminate after backup.</p> |

Note:

1. The MUFU Video App will auto sync the camera's date/time with your smartphone.
2. App layout and features are subject to change, depending on the software version. Refer to the Google Play Store or iOS App Store for the latest updates.

2 Playback, delete, and download recordings

Use this feature to playback, delete recordings, or download recordings from the camera to your smartphone.

1. Tap the icon  [Camera File] to enter file playback list. Recording will stop.
2. The files save in the V11S' microSD card will be listing on your smartphone. There are three folders, Loop, Snapshot and Locked. Tap the preview thumbnail to playback the file.



3. Tap the right top corner “Select” and pick up the files that you want to delete or download and tap below icon to execute.



| Icon | Description |
|---|----------------------------------|
|  | Download the file to smartphone. |



Delete file from V11S's microSD card.



Downloaded file will mark as "Downloaded" on preview thumbnail. It can be opened from "Album" without Wi-Fi connection to the camera.

Note :

1. If recordings have no audio, check if Microphone is OFF in the menu. For video playback, we recommend VLC Media Player.
2. Deleted files cannot be recovered. Backup any important files before deleting them.
3. The snapshot is activated by app. The image file will be stored both in microSD card in the camera and "Album" folder of MUFU Video app. The file will be marked as "Downloaded" on preview thumbnail.
4. If you plan to download a large number of videos and photos, we recommend connecting directly to a PC/Mac via USB Type-C cable.

3 Album



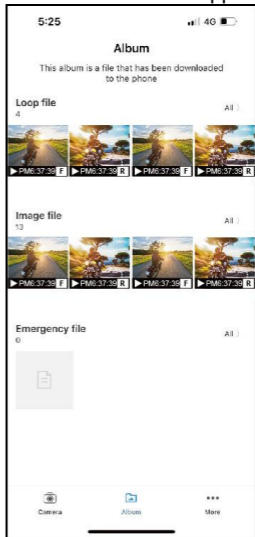

Use this feature to playback or delete the file that you download to your smartphone. The file can be opened and reviewed without Wi-Fi connection to the camera.

1. Tap the icon  [Album] below the home page. The camera will stop recording if it's connected with app.

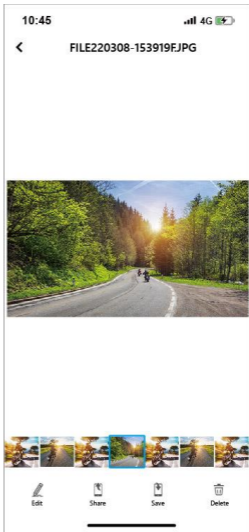
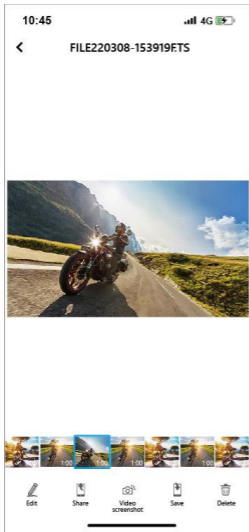

Tap the file from preview thumbnail to playback, delete or edit.



| Icon | Description |
|---|---|
|  | Edit the video or photo. |
|  | Share the video or photo to social media. |
|  | Video screenshot. |
|  | Save the video or photo to smartphone's album. When the file is saved, the screen will show a message of "Save to smartphone's album successfully." and smartphone's album will automatically create a folder named "MUFU Video". |
|  | Delete the file downloaded in App's Album. The file in the microSD card in the camera is still existed. |

4 Camera Setting

Use this feature to set up your preferred options.



1. Tap icon  [Camera Setting] on main screen. The camera will stop recording.
2. See available settings below and adjust to your preferred options.

| Menu | Description | Options |
|-------------------------------------|---|-------------|
| Vibration Detection to Power On/Off | When pick up the helmet with camera mounted, the camera will automatically power on and start recording. If the helmet idles for 3 minutes, the camera will power off automatically. *The camera must be mounted with the mount. | On / Off |
| Audio Recording | Enable/Disable audio recording. | On / Off |
| Recording Interval | Set the length of each individual recording. | 1min / 3min |
| Tilt Sensor | Calibrate the Tilt-Sensor for topple-over detection. | Yes / No |
| Emergency Recording | Enable/Disable emergency recording function. *The emergency recording folder is occupied 20% of memory card. Even it turns off, this capacity is still occupied. | On / Off |

| | | |
|--------------------|--|----------------------|
| Format | Format the memory card in the camera. This will delete all contents permanently. | Yes / No |
| Wi-Fi Turn-on Time | Set the Wi-Fi activation duration. *Active Wi-Fi will decrease total recording hours | Always on / 3min off |
| Watermark | Watermark includes brand, model, car speed, longitude and latitude, and date/time. | On / Off |
| EV Setting | Set the Exposure Value of camera | +3 ~ -3 |
| Wi-Fi Password | Change the Wi-Fi password. (Default: 12345678) | |
| Default Settings | Reset the camera to factory default settings. | Yes / No |
| Firmware Version | Indicates the current firmware version of the camera. | |

13. Final Check

- Peel off lens protective films**
- Fully charge the camera**
- Tilt sensor calibration done**
- Format microSD card done**
- MicroSD card slot cover is closed tightly**
- The main unit mount is fixed tightly**

Specifications

| Item | Description |
|-----------------------|--|
| Image Sensor | 2MP CMOS sensor |
| Effective Pixels | 1920 (H) x 1080 (V) |
| Storage Media | Suggest V30 or higher microSD card, up to 128GB |
| Lens | Wide angle fixed focus waterproof lens Aperture : up to F/1.8 |
| Video File | Resolution : 1080P/ 30 fps |
| | Format : TS |
| Picture File | Use App to take snapshot |
| | Format : JPG |
| G-sensor | 3-Axles G-Force sensor |
| GPS | N/A |
| Wi-Fi | Built-in |
| Microphone | Built-in |
| Battery | 2000mAh |
| Operating Temperature | -10° ~ 60° C |
| Operating Humidity | 20 ~ 70% RH |





| Item | Description |
|---------------------|-----------------------|
| Storage Temperature | -20° ~ 70° C |
| Size | 45.0 x 72.1 x 30.0 mm |
| Weight | Approximately 88g |

Built-in IEEE 802.11g/n (HT20) Wi-Fi chip: RTL8188FTV

| | |
|-----------------|--------------|
| Wi-Fi Frequency | 2412~2462MHz |
| Wi-Fi Channel | Ch1~Ch11 |

Optional Accessories

Contact distributor to purchase additional accessories for the camera.

| Helmet Mount | GoPro Type Mount | Rear-view Mirror Mount |
|--|---|---|
|  A black plastic helmet mount with a central slot for a camera and a small flap on the top left. |  A black plastic GoPro-style mount with a camera slot and a circular base for mounting to a surface. |  A black plastic rear-view mirror mount with a camera slot and a curved base for mounting to a mirror. |
| Moto/Car Mount | License Plate Mount | |
|  A black plastic Moto/Car mount with a wide horizontal bar for mounting to a handlebar or similar structure. |  A black plastic License Plate mount with a camera slot and a circular base for mounting to a license plate. | |



DIY quick installation



Hall sensor detection, buckle and record.



Dedicated app for preview and playback.



Built-in 2000mAh battery



Tilt Sensor detects if the motorcycle has toppled over and automatically locks the recording.



Camera IP66 Waterproof